

#18

HENGE

*A Collection
Made to Amaze*

INDEX

BAR

OZONE L PP. 48, 51, 53, 54, 55, 58, 61, 65

BOOKSHELVES

CAGE B WINESTORAGE PP. 48, 51, 53, 55, 63, 64
LOOM PROGRAM PP. 79, 84, 95, 202, 206, 209, 212
STILE SET PP. 138, 142, 148

CABINETS

SIDE X EVO PP. 99, 105, 106, 109
SIDE X EVO HIGH PP. 223, 213

SOFAS

GELLY POUF PP. 69, 73, 79, 134, 135, 172, 188, 238, 256, 258
LAILAND SOFA PP. 11, 38, 44, 45, 47, 69, 172, 180, 183, 258
OPUS SOFA PP. 72, 79, 80, 170, 186, 201

ARMCHAIRS

HEXAGON ARMCHAIR PP. 201, 210
VOYAGE ARMCHAIR PP. 79, 86, 88

COFFEE TABLES

BE MINE COFFEE TABLE XL PP. 172, 176
OCTAGON TABLE PP. 38, 43, 44, 45, 79, 169, 179
PRIMITIVE TABLE PP. 69, 72, 88, 92, 201
TWISTABLE PP. 38, 69, 79, 201, 210, 229, 231
TWISTABLE CONSOLLE PP. 137

TABLES AND CHAIRS

HEXAGON LOUNGE PP. 188, 192
SAVANNAH CHAIR PP. 31, 32, 35, 118, 119, 121, 214, 217
OXYMORON TABLE PP. 203, 214, 216, 217, 221
SCULPTURE TABLE PP. 24, 32
SHIFT TABLE LOUNGE XL PP. 188, 192

LIGHTING

ELBUS LAMP PP. 8, 9, 38, 201
GHOST TABLE LAMP PP. 152
REFLEX LIGHT PP. 20, 21
STARLIGHT LAMP PP. 111, 112, 113, 122, 126, 187, 188
STARLIGHT HORIZONTAL PP. 68, 79, 99, 101, 102, 103, 255

NIGHT COLLECTION

NOCTIS BED PP. 229, 234, 238
NOCTIS TALL CHEST
5 DRAWERS PP. 242
NOCTIS VANITY PP. 241, 247, 248, 250, 251, 258
TWISTABLE CONSOLLE
NIGHT STAND PP. 234, 238

THE JOURNEY WITHIN: EXPLORING THE INSIDE OF THINGS

A journey that began by looking at our native land with new eyes, seemingly suspended in a timeless dimension and untouched by modernity, but which appears to the patient observer as being authentic and of excellent craftsmanship, handed down from one generation to the next, the highest expression of Italian know-how.

A journey, directed by Massimo Castagna, also looking within ourselves, a moment of reflection on what we would like to have in our home and on contemporary living. A project that continues today, keeping with its initial spirit, growing richer with every step, evolving with each experience, offering new visions and new inspirations; a path passing through places and times, reinterpreting the present.

We conceive and create products in which design and the expressive force of natural materials become an organic whole, a combination of space and nature.

Objects that are much more than a piece of furniture: a presence that ages slowly, together with us, day after day, developing that unique patina that only time can create.

COLLECTION DESIGNED AND COORDINATED
BY MASSIMO CASTAGNA



We produce unique masterpieces, each with a soul that cherishes the journey leading to its creation.



A journey in search of the difficult balance between the analysis of the mind and the reasons of the heart, inspired by our personal sense of beauty and passion for intimate and familiar things.

It is precisely for this reason that people are at the center of our thoughts and our interest: for their ways of living, for their desires and the evolution brought about by changing times and customs, factors that influence our needs and consequently what and how we should approach our projects.







Working natural materials by hand, we know that each piece is unique and that every product will be different from the next.

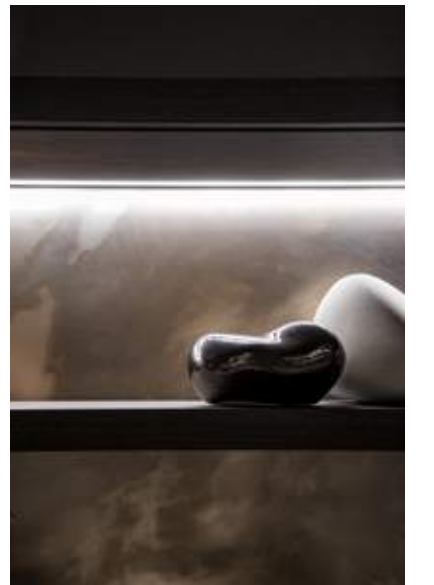

chapter

1

The Henge world is incredibly rich in ideas and materials that define a personal mood: woods with deep colors and grain, stones as works of art, soft, smooth and supple fabrics and leather, metals burnished and aged by hand, along with sophisticated materials such as steel fabrics, finished and decorated Etna lava stone, swamp oak, Titanium stone. You cannot fool nature, or copy the beauty that it creates, just as you cannot imitate the sensations that only natural materials can convey.

















Matter is rediscovered in its essence and in the fascination of its imperfection.



Our approach to projects knows no limits in regard to materials, technology and form.





BEING EXCEEDS THE BOUNDARIES OF DIMENSIONS

Every Henge piece is made exclusively by one of our craftsmen, from production to finishing: this guarantees that every product has its own maximum expressiveness, upholding the integrity of the brand. This is the potential of a kind of beauty that transcends the limits of lines.

Matter for matter, like art for art, is transformed by the hands of those who interpret and translate it into objects that define our relationship with life.

It is in this relationship between creator and creations that Henge's philosophy finds its roots: in the exchange of emotions between surfaces and in unique tactile sensations and experiences.













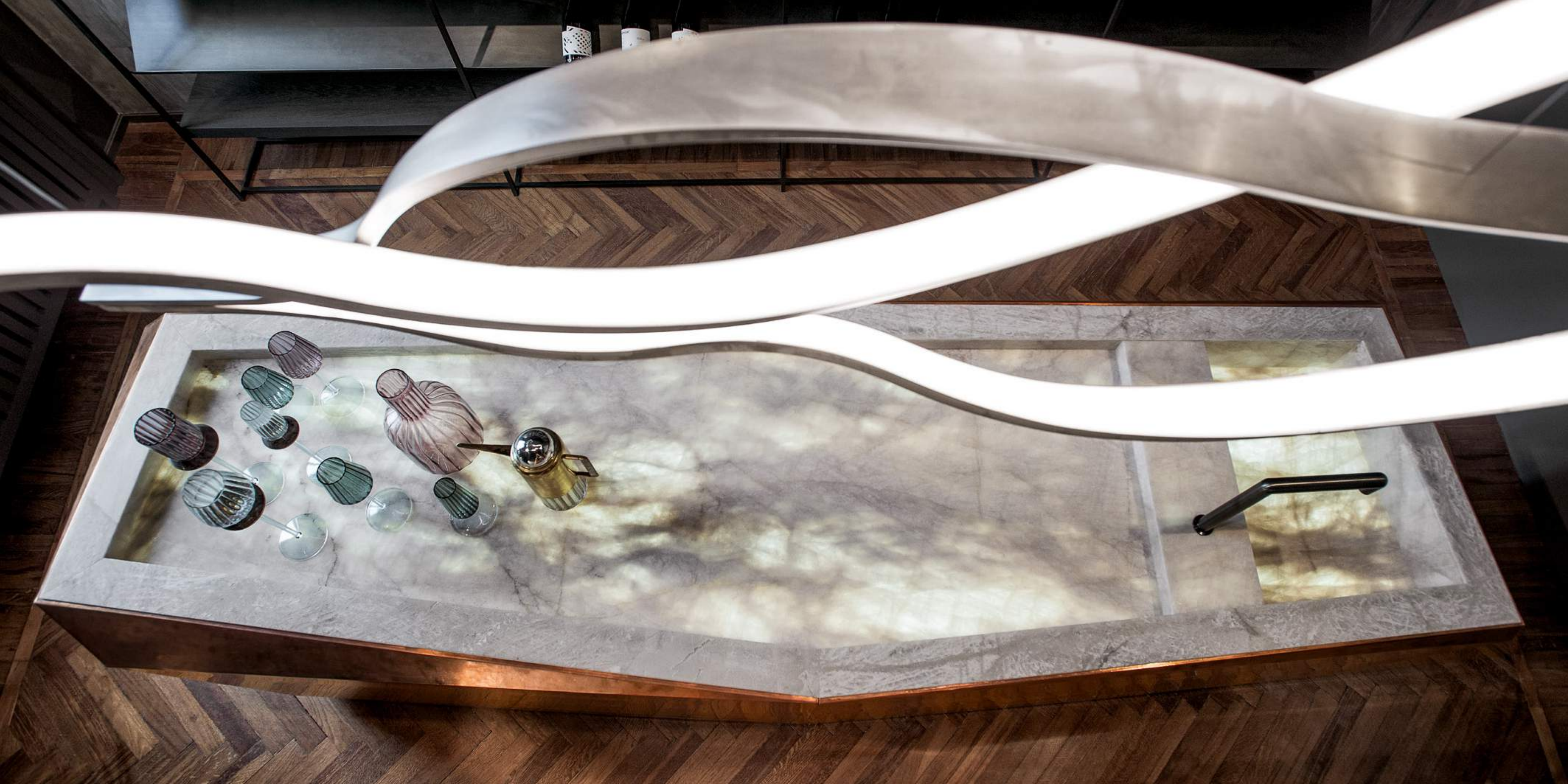







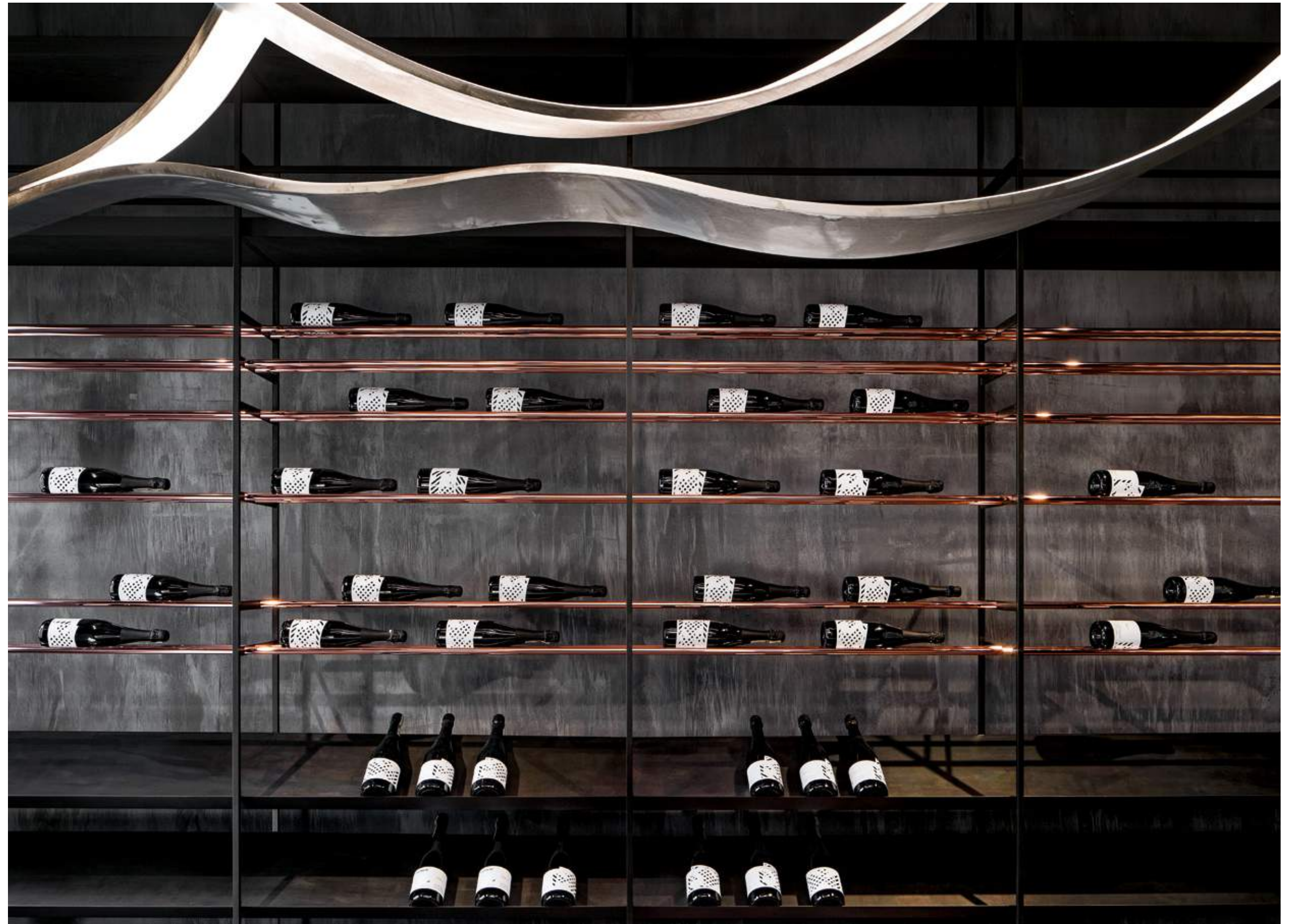















Different materials touch each other in seamless harmony.





Our DNA resists
the dynamics of
production cycles
and conformity to
any one style.









The finished products open up a world of discovery that speaks not only to each product's design but also to the space they come to inhabit.





THE TIMELESS PATINA OF A CHERISHED RAW BEAUTY

Since its inception, Henge's guiding philosophy lies in the rejection of industrial principles. Instead, the Henge design concept connects each client with an experience where a simple piece of furniture becomes a travel companion. The most brilliant minds and hands imagine, design and finish these creations that become part of someone's life: a magnificent presence that embraces our uniqueness, making each of us special. Henge's craftsmen create pieces with a pure soul that, in a unique way, communicate and get in touch with the world around it.









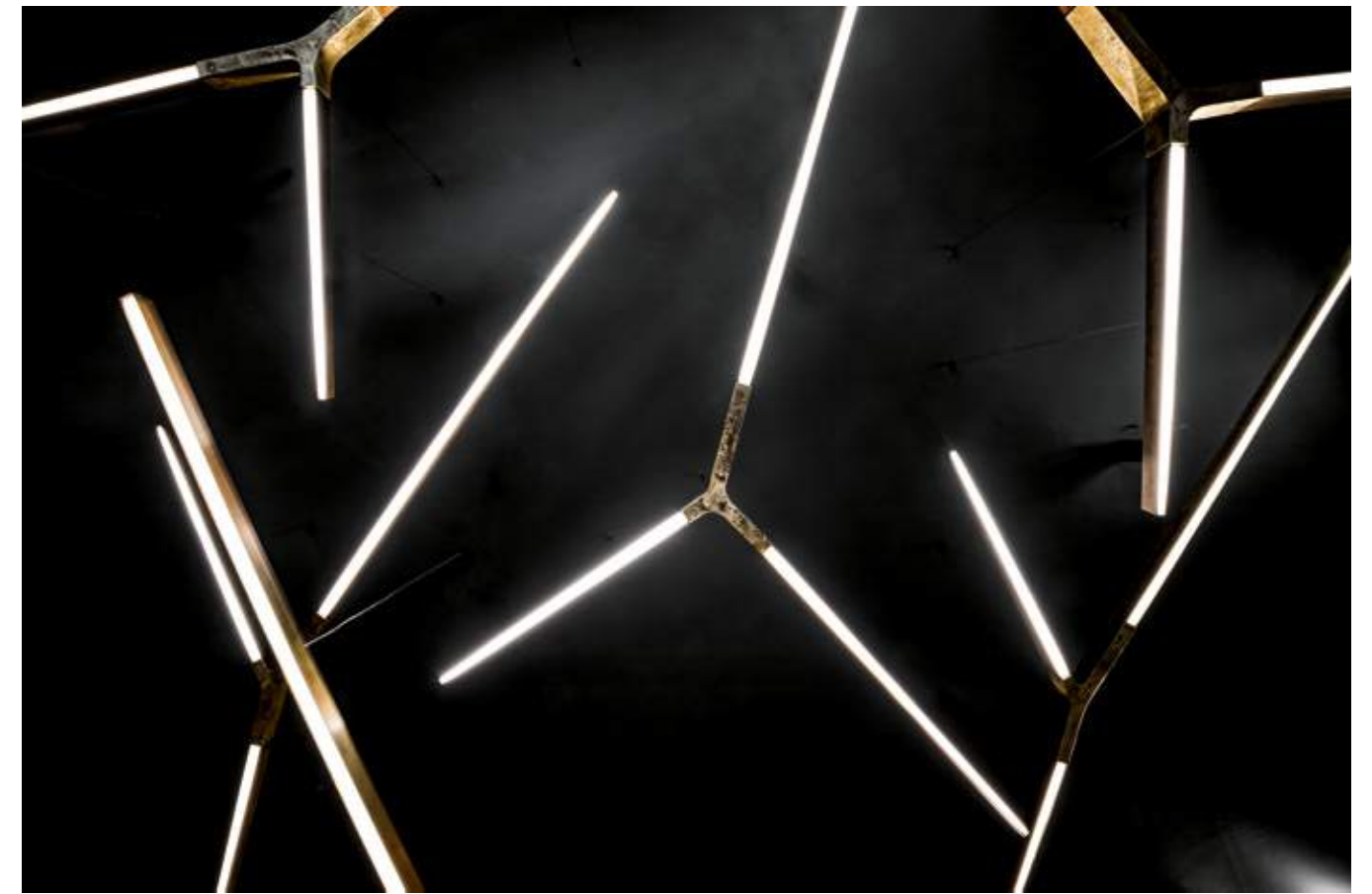

























Life is a craving
for contrasts that
generate evocative
antitheses that we try
to understand.





By stepping outside the box, creative thinking can begin to engage in lifestyle scenarios, centered around people and their desires.





















chapter

2

LEARNING FROM NATURE: A JOURNEY INSIDE THE EXPERIENCE OF DESIGN AND LIFE

Nature speaks in many voices, from its soft murmurs to its disruptive songs. It is a tireless soul that changes with each encounter; it revolutionizes its existence without losing itself, emanating its magnificent power even in the most delicate gestures.

Henge is the essence of listening to this incessant orchestra - a stone that has passed through time and has witnessed its symphonies, deeply touched by a nature that is ready to reveal itself to those who can hear beyond the silences.

The best Italian artisan work extrapolates the images suggested by nature; it sculpts the surfaces as if the object already lives in the material, eagerly waiting to exist.

Man is part of this irrepressible flow of ideas, of force and of evolution, and knows its language. Translating it is an art for the few who know how to immerse themselves in the world's soul and understand its secrets. Henge's history stems from this deep bond: from the unrestrained inspiration from nature that makes imperfection and inimitability its greatest beauty and from the innate ability of man to imagine.



“You see a block, think about the image: the image is inside, you just need to undress it.” — Michelangelo Buonarroti



AN IDEA, A PROJECT: FOREST FUSION

The forest contains the poetry of elements united in symbiosis. It is an intertwining of lives, lights and shadows that connect to such a point that they can only be described as a whole. Hierarchies are lost in a fusion of souls and uniqueness. They touch and hold one another, becoming something that is neither one nor the other but retains their traces. The forest, with its dense plot of stories and emotions, writes an ancient tale that inspires Henge's creation of a technique that sews together these unique souls: Forest Fusion. In their union, these fragments of matter are the full expression of their past, made by the hands that impart centuries of artisan knowledge in their fusion.

Each unique piece is selected, cut and placed in a sartorial painting that bears the signature of the best Italian craftsmanship.

Processing is the instrument through which this natural ensemble finds form and voice, in an intimate story that speaks to contact with the fingers. Forest Fusion's tactile experience is to close one's eyes and feel the forest's breath, its innate depth and perfect balance. This new technique merges with Henge's philosophy of creating a resonance between kindred spirits that become companions on a journey inside material and life.







Every morning one of our craftsmen offers his hands and his art to make each Henge product unique. We create your everyday experience.











Spaces, places and
tactile experiences to
make it unforgettable:
a journey requires
nothing more
than that.

















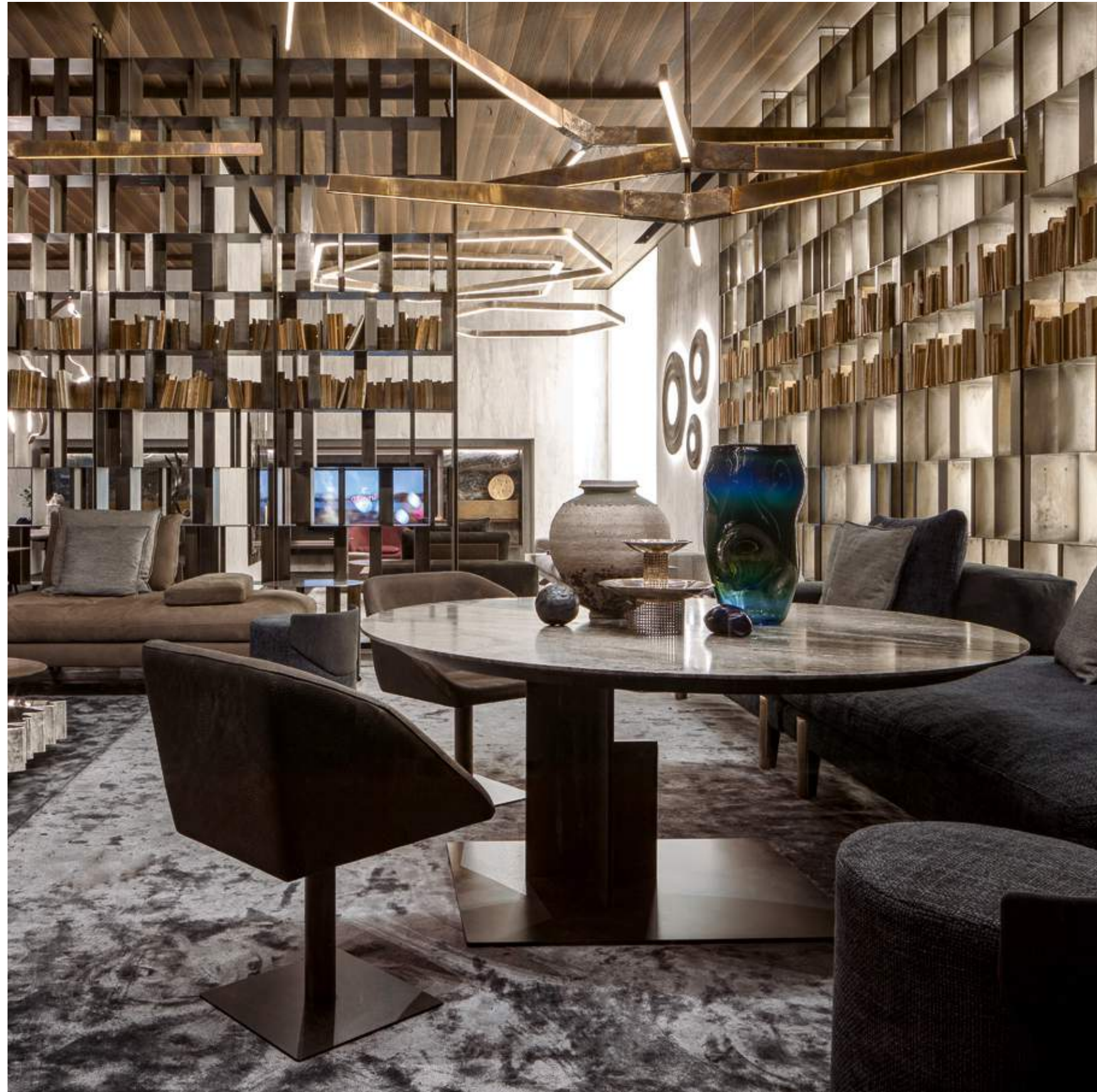

























Experimentation
creates a sort of
intellectual tension
that moves us and
binds us to every
lived experience.





chapter

3

There is a flow in the universe that travels through matter. It is a pulsating energy that crosses the skies, the earth and its bodies. It flows in the veins of the leaves, in the marble of the quarries, in electric cables, in man's throbbing arteries, in his synapses. It is an impulse that goes from the origin of everything, reaching its most remote corners, of atom in atom, across those imperceptible bonds that form the network of existence. We live through connections. We live through connections that exist independently of us. We are actors and spectators, messengers, admirers, critics, philosophers, dancers. Every man is a part of everything and connected to the whole.



A DANCE OF LIVING BODIES

That is how we define the experience - the feeling of being able to touch an intimate entity hidden in matter, of recognizing it as our own, of understanding its secrets, in infinite bundles of energy that run through us and in all directions.

It is as if the smallest shape of the universe can't be reduced to a single point. Instead, it is what lies between that tiny point and the others and the connections that exist between them.

We dance a dance of bodies to the rhythm of the mystery of life, connected to a single soul for whom we try to find a name. A vibration that resounds among the knots of the wood, between the nuances of a stone, between the reflections of a metal and the breath of one's skin.















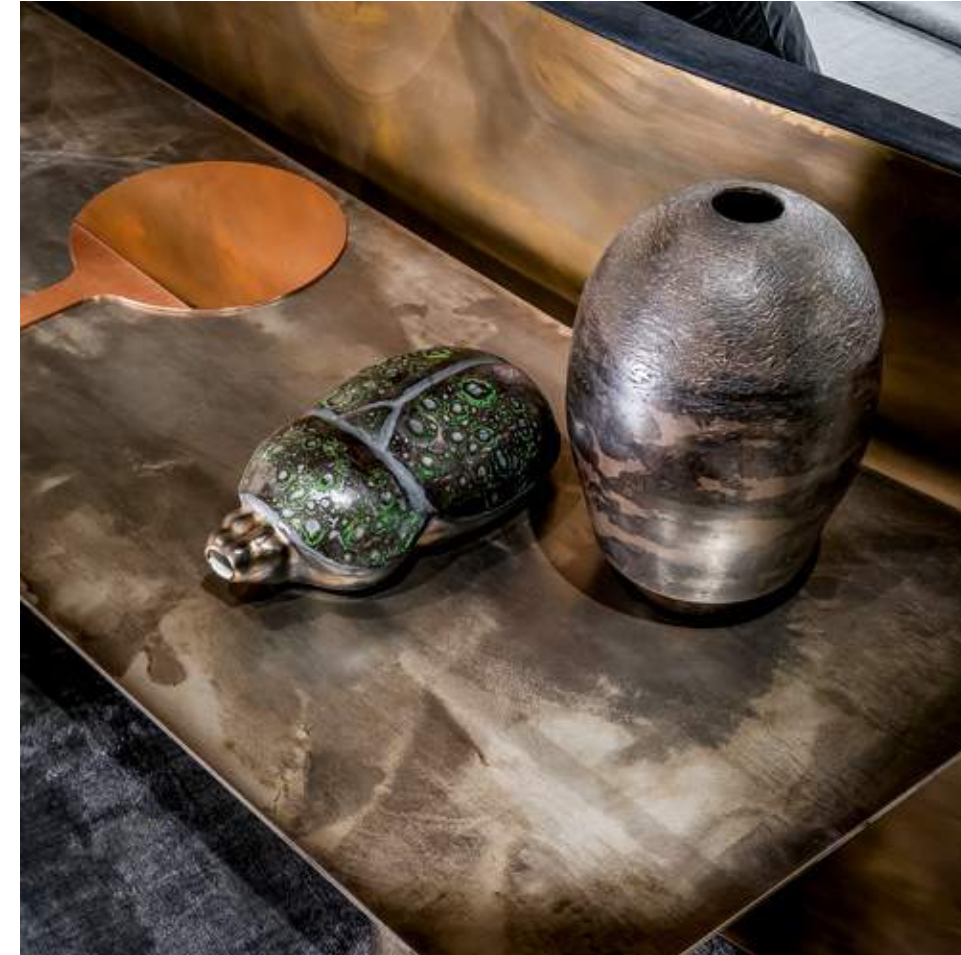

“I learned that the world has a soul, and that whoever understands that soul can also understand the language of things.” — Paulo Coelho

The connection lives in the law of change and transcends it. It evolves without detaching itself from the parts; some are close enough to touch one another, while others are so far apart that they are forgotten.









Veins. Roots.
Galaxies.



The tiger's stripes.
Synapses. Hands.



Roads. Feelings.
The weave
of a shirt.

Experiences.





"It happens that the kindships of the soul they do not reach the gestures and the words,
but they remain effused like a magnetism." — Eugenio Montale



Henge pieces are fragments of that soul that binds them together, recomposing everything into a puzzle of living bodies made of different materials.

Through a single
encounter, one
can understand
everything.

technical data

4

OZONE L

Bar

Design

Massimo Castagna

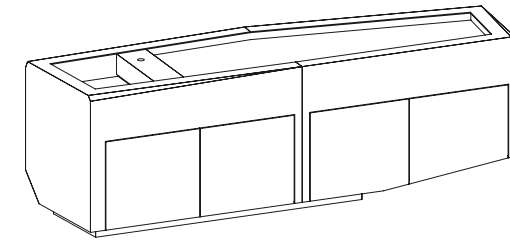

STRUCTURE

Structure, drawers in Krion®, high strength, waterproof and antibacterial solid surface, finish high pressure H-folding black burnished copper. Internal drawers with internal partitions in black burnished steel and bottom in leather E-Type black.

TOP AND SINK

Backlighted White Cristal or stone thickness 2 cm.

STRUCTURE FINISHES

Internal structure in Krion®, high strength, waterproof and antibacterial solid surface, with external finish high pressure H-folding black burnished copper.

TOP AND SINK FINISH

Backlighted White Cristal or stones from our range.

DIMENSIONS

cm 300x86x94h

SIZES CAN BE CUSTOMIZED

STRUTTURA

Struttura, cassetti in Krion®, superficie solida ad alta resistenza, impermeabile e antibatterica, finitura in rame brunito nero H-folding ad alta pressione. Cassetti interni con divisori interni in acciaio brunito nero e fondo in pelle E-Type nero.

TOP E LAVATO

In White Cristal retroilluminato o pietra spessore 2 cm.

FINITURE STRUTTURA

Struttura interna in in Krion®, superficie solida ad alta resistenza, impermeabile e antibatterica, finitura in rame brunito nero H-folding ad alta pressione.

TOP E LAVELLO

In White Cristal retroilluminato o nelle pietre nella gamma a campionario.

DIMENSIONI

cm 300x86x94h

PERSONALIZZABILE A DISEGNO

CAGE B WINESTORAGE

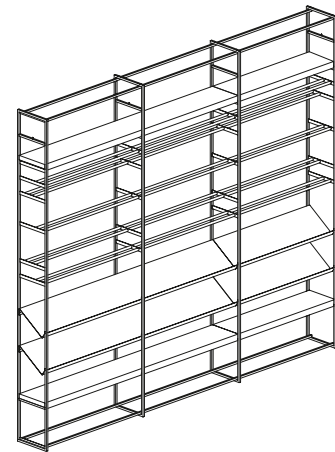

STRUCTURE

Square solid steel or brass pipe uprights cm 1,5x1,5 with steel or brass shelf support.

STRUCTURE FINISH

Black burnished Steel, burnished Platino, burnished Titano burnished Brass or black burnished Brass.

SHELVES

5 cm thickness plywood veneer thermowood, oil finish, or swamp wood as per our range. Metal shelves in Black burnished Steel, Burnished Titano, Burnished Platino, Burnished Brass, Black burnished Brass. Wine support Ø 2 cm in Black burnished Steel, Burnished Titano, Burnished Platino, Burnished Brass, Black burnished Brass, shine Copper.

DIMENSIONS

cm 198x30x260h
cm 297x30x260h

SIZES CAN BE CUSTOMIZED

Metal frame wine storage

Design

Massimo Castagna

STRUTTURA

Montanti in acciaio o ottone quadro 1,5x1,5 con supporti per ripiani in acciaio o ottone.

FINITURE STRUTTURA

Acciaio brunito nero, Titano brunito, Platino brunito ottone brunito o ottone brunito nero.

RIPIANI

Legno listellare spessore 5 cm finitura legni termo trattati nelle finiture a campionario, rovere di palude, olmo di palude. Ripiani inclinati in metallo finitura acciaio brunito nero, Titano brunito, Platino brunito, ottone brunito, ottone brunito nero. Supporti bottiglie in acciaio brunito nero, Titano brunito, Platino brunito, ottone brunito, Rame lucido.

DIMENSIONI

cm 198x30x260h
cm 297x30x260h

PERSONALIZZABILE A DISEGNO

CAGE B WINERY CM 198X30 H 260

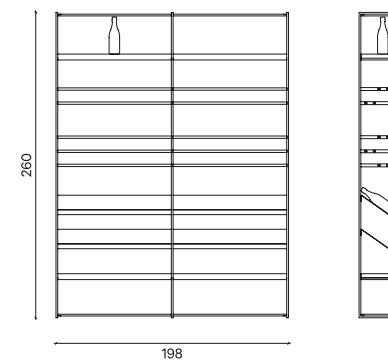

CAGE B WINERY CM 297X30 H 260

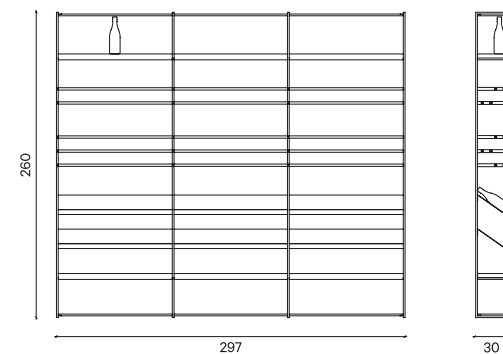

STILE SET

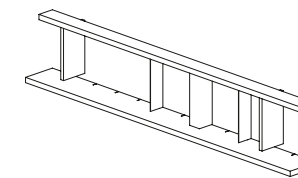

STRUCTURE

Structure in 3,6 cm thick solidwood Uprights in 2,5 cm thick solidwood

FINISH

Heat treated woods as our samples and Swamp Oak, Swamp Elm oil finish based on natural wax and water.

STORAGE UNITS

2,5 cm thick solidwood. Optional metal finish Burnished black steel, Burnished Titano, Burnished Platino, Burnished Brass, Burnished Black Brass, Scratched Brass, by hand using traditional techniques.

TV PANEL

Solid wood covered with black burnished steel cm 190x4x90h

INTERNAL PARTITIONS

3 mm solid metal in Burnished black steel, Burnished Titano, Burnished Platino, Burnished Brass, Burnished Black Brass, Burnished black steel, Scratched Brass, by hand using traditional techniques. H-Silver, Scratched H-Silver®, H-Silver® S, H-Silver® B, Shine Brass, Shine copper. 9 cm solidwood folded with metal in Burnished black steel, Burnished Titano, Burnished Platino, Burnished Brass, Burnished Black Brass, Scratched Brass, by hand using traditional techniques. H-Silver, Scratched H-Silver®, H-Silver® S, H-Silver® B, Shine Brass, Shine copper.

WALL LIGHT KIT

Sidelight top-bottom, cover in Burnished black steel, Burnished Titano, Burnished Platino, Burnished Brass, Burnished Black Brass, Scratched Brass, by hand using traditional techniques. H-Silver, Scratched H-Silver®, H-Silver® S, H-Silver® B, Shine Brass, Shine copper. Available 2700K 160 x 15 cm led 3000K - 21 W
240 x 15 cm led 3000K - 33 W

DIMENSIONS

cm 160x20x25h (standard internal partitions n.1 of 0,3 cm and n.1 of 9 cm)
cm 160x20x31h (standard internal partitions n.1 of 0,3 cm and n.1 of 9 cm)
cm 160x20x43h (standard internal partitions n.1 of 0,3 cm and n.1 of 9 cm)
cm 240x20x25h (standard internal partitions n.2 of 0,3 cm and n.1 of 9 cm)
cm 240x20x31h (standard internal partitions n.2 of 0,3 cm and n.1 of 9 cm)
cm 240x20x43h (standard internal partitions n.2 of 0,3 cm and n.1 of 9 cm)
cm 160x32x25h (standard internal partitions n.1 of 0,3 cm and n.1 of 9 cm)
cm 160x32x31h (standard internal partitions n.1 of 0,3 cm and n.1 of 9 cm)
cm 160x32x43h (standard internal partitions n.1 of 0,3 cm and n.1 of 9 cm)
cm 240x32x25h (standard internal partitions n.2 of 0,3 cm and n.1 of 9 cm)
cm 240x32x31h (standard internal partitions n.2 of 0,3 cm and n.1 of 9 cm)
cm 240x32x43h (standard internal partitions n.2 of 0,3 cm and n.1 of 9 cm)

Storage unit cm 160x32x31h / Storage unit cm 240x32x31h
TV panel cm 190x90h

SIZES CAN BE CUSTOMIZED

Suspended modular bookshelf

Design

Massimo Castagna

STRUTTURA

Struttura in legno listellare spessore 3,6 cm Montanti in legno listellare spessore 2,5 cm

FINITURE

Legni termizzati nelle finiture a campionario, rovere di palude, olmo di palude, finitura a base di cere naturali ad acqua.

CONTENITORI

Legno listellare spessore 2,5 cm nelle finiture a campionario. Optional finiture metallo acciaio brunito nero, Titano brunito, Platino brunito, ottone brunito, ottone brunito nero, ottone graffiato.

PANNELLO PORTA TV

In legno listellare rivestito con acciaio brunito nero cm 190x4x90h

PARTIZIONI INTERNE

In metallo spessore 3 mm in acciaio brunito nero, Titano brunito, Platino brunito, ottone brunito, ottone brunito nero, ottone graffiato, H-Silver®, H-Silver® graffiato, H-Silver® S, H-Silver® B, Shine Brass, Shine copper. In metallo piega spessore 9 cm in acciaio brunito nero, Titano brunito, Platino brunito, ottone brunito, ottone brunito nero, ottone graffiato, H-Silver®, H-Silver® graffiato, H-Silver® S, H-Silver® B, ottone lucido, rame lucido.

WALL LIGHT KIT

Luce radente alto-basso copertura in acciaio brunito nero, Titano brunito, Platino brunito, ottone brunito, ottone brunito nero, ottone graffiato, H-Silver®, H-Silver® graffiato, H-Silver® S, H-Silver® B, ottone lucido, rame lucido. Disponibile 2700K 160 x 15 cm led 3000K - 21 W
240 x 15 cm led 3000K - 33 W

DIMENSIONI

cm 160x20x25h (partizioni interne previste n.1 da 0,3 cm e n.1 da 9 cm)
cm 160x20x31h (partizioni interne previste n.1 da 0,3 cm e n.1 da 9 cm)
cm 160x20x43h (partizioni interne previste n.1 da 0,3 cm e n.1 da 9 cm)
cm 240x20x25h (partizioni interne previste n.2 da 0,3 cm e n.1 da 9 cm)
cm 240x20x31h (partizioni interne previste n.2 da 0,3 cm e n.1 da 9 cm)
cm 240x20x43h (partizioni interne previste n.2 da 0,3 cm e n.1 da 9 cm)
cm 160x32x25h (partizioni interne previste n.1 da 0,3 cm e n.1 da 9 cm)
cm 160x32x31h (partizioni interne previste n.1 da 0,3 cm e n.1 da 9 cm)
cm 160x32x43h (partizioni interne previste n.1 da 0,3 cm e n.1 da 9 cm)
cm 240x32x25h (partizioni interne previste n.2 da 0,3 cm e n.1 da 9 cm)
cm 240x32x31h (partizioni interne previste n.2 da 0,3 cm e n.1 da 9 cm)
cm 240x32x43h (partizioni interne previste n.2 da 0,3 cm e n.1 da 9 cm)

Contenitori cm 160x32x31h / Contenitori cm 240x32x31h
Pannello porta TV cm 190x90h

PERSONALIZZABILE A DISEGNO

STILE SET EVO LIBRERIA CM 160X32 H 25

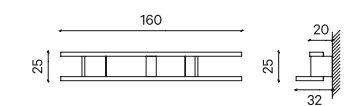

STILE SET EVO LIBRERIA CM 160X32 H 31

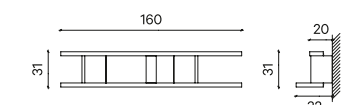

STILE SET EVO LIBRERIA CM 160X32 H 43

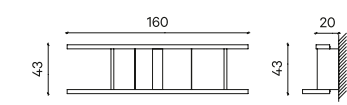

STILE SET EVO LIBRERIA CM 240X32 H 25

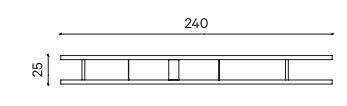

STILE SET EVO LIBRERIA CM 240X32 H 31

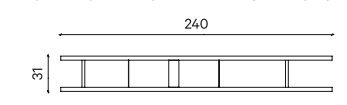

STILE SET EVO LIBRERIA CM 240X32 H 43

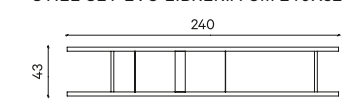

STILE SET BOX CM 160X32 H 31

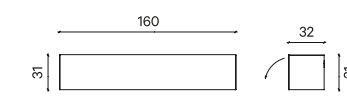

STILE SET BOX CM 240X32 H 31

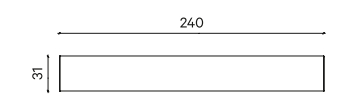

STILE SET TV PANEL CM 190 H 90

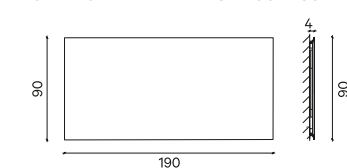

LOOM PROGRAM

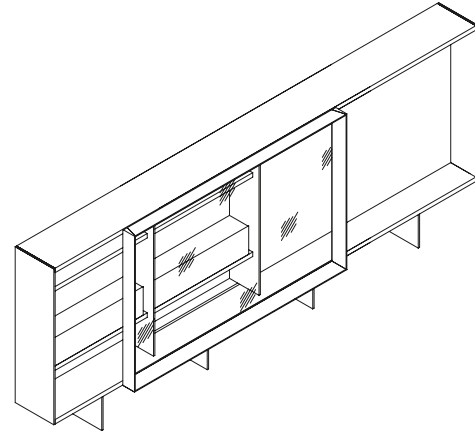

Loom system shelves
and shelves and storage

Design
Massimo Castagna

STRUCTURE

Top, base, shelves in thickness 4 cm solidwood veneer thermowood or swamp wood from our range. Sides in 1,4 cm wood veneered thermowood or swamp wood from our range or covered with black burnished steel. Optional metal backrest in black burnished steel, burnished Platino, burnished Titanio, burnished Brass or stone from our range. Led light recessed into the top (downward).

STORAGE UNITS

Solidwood thickness 2 cm veneer, with flap door. Optional metal finishes: black burnished steel, burnished Platino, burnished Titanio, burnished Brass; black Burnished Brass. Cm 100x20x25h.

TV PANEL

In solid wood covered with black burnished steel, backlighted.

BASE

Height 35 cm in black burnished steel.

DOORS

Glass sliding door with metal frame and Stopsol Supersilver 0,5 cm
cm 180x11,5x140h
cm 220x11,5x140h

DIMENSIONS

cm 360x40x175h with TV unit
cm 450x40x175h with winery
cm 440x40x175h
cm 440x40x175h with TV unit
cm 550x40x175h with TV unit

SIZES CAN BE CUSTOMIZED

STRUTTURA

Top, base e ripiani in legno listellare spessore 4 cm nelle finiture termizzate a campionario o rovere di palude e olmo di palude o rivestito in metallo finitura acciaio brunito nero. Optional schienali in finitura acciaio brunito nero Titanio brunito, Platino brunito, ottone brunito o pietra nelle finiture a campionario. Luce a led incassata nel top con puntamento verso il basso.

CONTENITORE

Struttura in legno listellare spessore 2 cm con anta a ribalta, nelle finiture struttura. Optional finitura metallo: acciaio brunito nero, Titanio brunito, Platino brunito, ottone brunito, ottone brunito nero. Cm 100x20x25h in appoggio.

PANNELLO PORTATV

In multistrato rivestito con acciaio brunito nero retroilluminato.

BASE

Altezza 35 in acciaio brunito nero.

ANTA

Anta scorrevole con cornice in metallo e vetro stopsol supersilver 0,5 cm
cm 180x11,5x140h
cm 220x11,5x140h

DIMENSIONI

cm 360x40x175h con porta TV
cm 450x40x175h con vineria
cm 440x40x175h
cm 440x40x175h con porta TV
cm 550x40x175h con porta TV

PERSONALIZZABILE A DISEGNO

LOOM PROGRAM TV CM 440X40 H 175

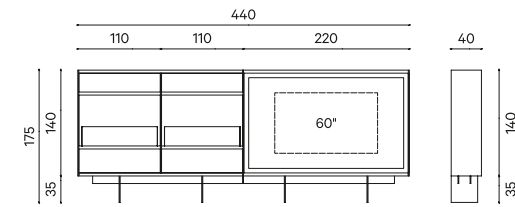

LOOM PROGRAM TV CM 550X40 H 175

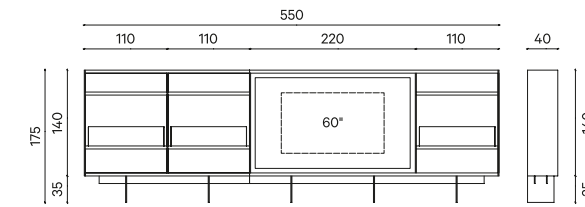

LOOM PROGRAM CM 440X40 H 175

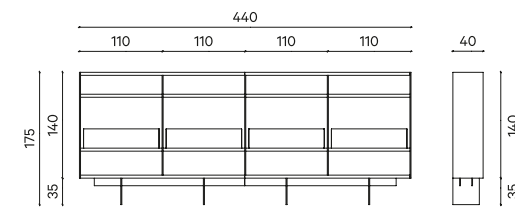

LOOM PROGRAM CM 450X40 H 175

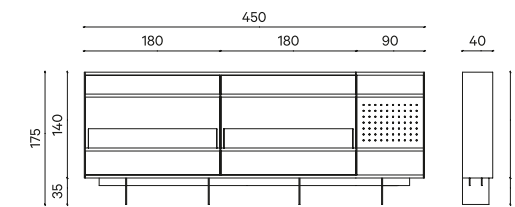

LOOM PROGRAM TV CM 360X40 H 175

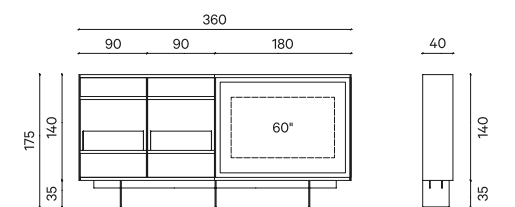

LOOM PROGRAM ANTA CM 180X11,5 H 140

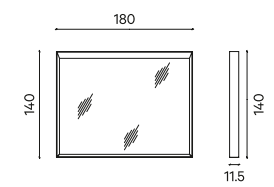

LOOM PROGRAM ANTA CM 220X11,5 H 140

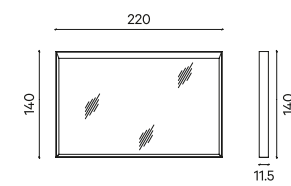

SIDE X EVO

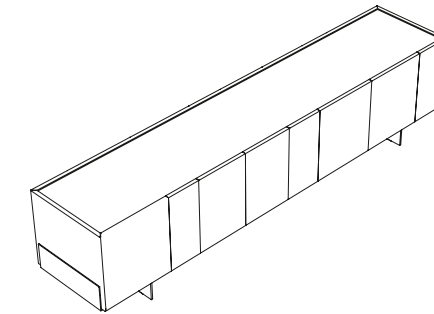

STRUCTURE

Structure in solid wood. Sides thickness 3,6, top and bottom thickness 5 cm and flush doors in 2,5 cm thick solid wood veneered or covered with metal.

TOP

In plywood thickness veneer, or covered with steel metal mesh; Stone top 2 cm thickness stone from our range.

FINISH

Heat treated woods oil finish based on natural wax and water Oak thermowood, Eucalyptus thermowood, Black Eucalyptus thermowood, Acacia thermowood or swamp woods: Swamp oak, Swamp Elm. Hand burnished metals using traditional techniques, result of an exclusive Henge recipe: Black burnished steel, Burnished brass, Black burnished brass, Scratched brass, H-silver, H-silver B, Silver Patina.

TOP FINISHES:

Stones from our range. Heat treated woods oil finish based on natural wax and water Oak thermowood, Eucalyptus thermowood, Black Eucalyptus thermowood, Acacia thermowood or swamp woods: Swamp oak, Swamp Elm. Burnished steel mesh tweed pattern.

BASE

Black burnished steel.

OPTIONAL

Back in metal finish (for metal version)
Internal backrest in Stopsol glass
Natural led light kit 3000K recessed into the top of the cabinet, downward.

DIMENSIONS:
cm 240x57x65h
cm 280x57x65h

Cabinet

Design

Massimo Castagna

STRUTTURA

Struttura in legno listellare. Fianchi spessore 3,6 e ante a filo spessore 2,5 in legno listellare in finitura legno termizzato, rovere di palude o olmo di palude.

TOP

In legno listellare nelle finiture a campionario o rivestito in rete metallica; top in pietra spessore 2 cm nella gamma a campionario.

FINITURE

Legni termizzati con finitura a base di cera naturale ad acqua rovere termizzato, eucalipto termizzato, eucalipto nero termizzato, acacia termizzato o rovere di palude e olmo di palude. Metalli bruniti a mano secondo tecniche tradizionali, risultato di una ricetta esclusiva Henge: acciaio brunito nero, ottone brunito, ottone brunito nero, ottone graffiato, H-silver, H-silver B, Silver Patina.

FINITURE TOP

Pietre nella gamma a campionario. Legni termizzati con finitura a base di cera naturale ad acqua rovere termizzato, eucalipto termizzato, eucalipto nero termizzato, acacia termizzato o rovere di palude e olmo di palude. Rete metallica.

BASE

Acciaio brunito nero.

OPTIONAL

Schienale in finitura metallo (per le versioni rivestite in metallo)
Schienale interno in vetro stopsol.
Kit luce led naturale 3000K incassato sotto il top, puntamento verso il basso.

DIMENSIONI
cm 240x57x65h
cm 280x57x65h

SIDE X EVO CM 240X57 H 65

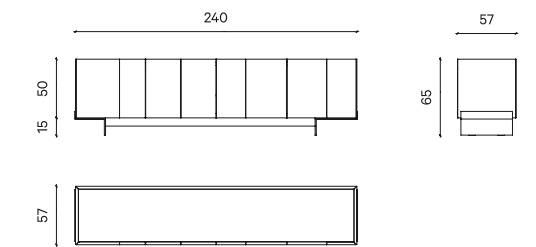

SIDE X EVO CM 280X57 H 65

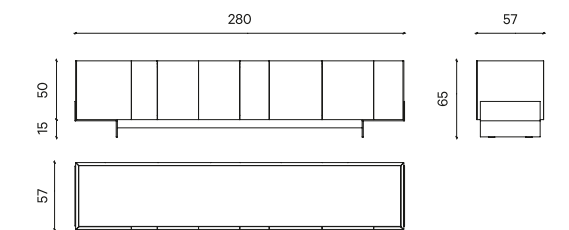

SIDE X EVO HIGHT CM 240X50 H 90

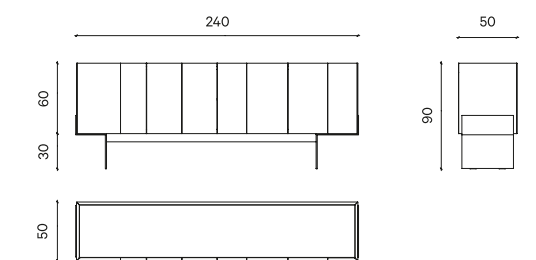

SIDE X EVO HIGHT CM 280X50 H 90

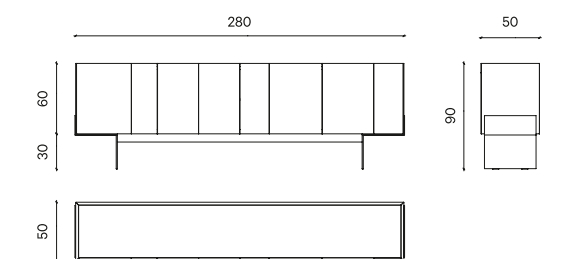

LAILAND SOFA

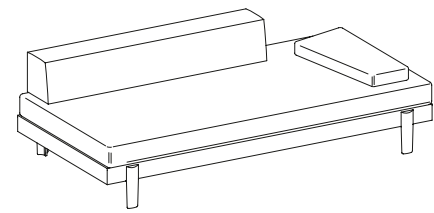

STRUCTURE

Solid wood with suspension provided by high density mat 10 cm high.

PADDING

Polyurethane foam, covered with 100% white cotton lining. Seat and back cushion with high resilience variable density polyurethane foam covered with 100% quilted goose down. Internal cover in 100% white cotton. Freestanding back rest and armrest high density polyurethane foam structural insert, covered with 100% quilted goose down. Internal cover 100% white cotton. Back cushions padded with 50% goose down, 50% polyester flake. Internal cover 100% white cotton.

BASE

In sandcasting brass, bronze or silver.

UPHOLSTERY

Fabric or leather from our samples catalogue. Leather version cover not removable.

DIMENSIONS

cm 105x75h
Seat cm 41h

NB Right/Rh and Left/Lh indicate the position of the armrest when facing the piece of furniture.

Seating system

Design

Massimo Castagna

STRUTTURA

Legno listellare con molleggio tramite materasso in poliuretano espanso alta densità altezza 10 cm.

IMBOTTITURA

In poliuretano espanso con densità variabile. Fodera in tessuto 100% cotone spigato bianco. Cuscini seduta e schienale in poliuretano espanso a densità variabile ricoperto con 100% piuma d'oca Bianca. Fodera 100% cotone spigato anti piuma bianco. Schienale e bracciolo in appoggio con inserto centrale in poliuretano espanso ad alta densità rivestito con 100% piuma d'oca. Fodera interna in 100% cotone spinato anti piuma bianco. Cuscino schienale con interno 50% piuma d'oca, 50% fibra poliestere vergine sferoidale. Fodera interna in 100% cotone spinato anti piuma bianco.

BASE

Ottone, bronzo o Silver con fusione a terra.

RIVESTIMENTO

Tessuti o pelli nelle finiture a campionario. Versione in pelle non sfoderabile.

DIMENSIONI

cm 105x75h
Seduta cm 41h

NB Per SX/DX s'intende la posizione che il bracciolo assume guardando l'elemento frontalmente.

LAILAND BASE CM 130 P 105

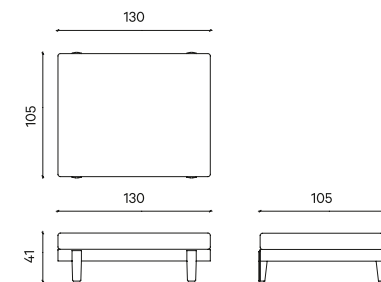

LAILAND BASE CM 160 P 105

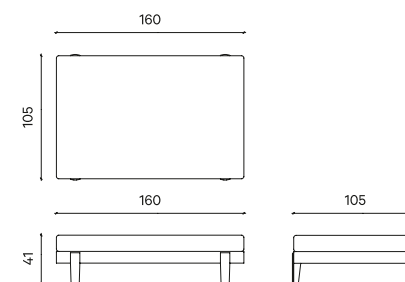

LAILAND BASE CM 190 P 105

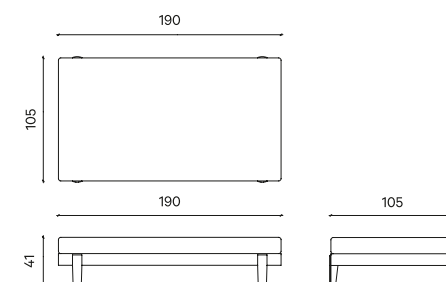

LAILAND BASE CM 220 P 105

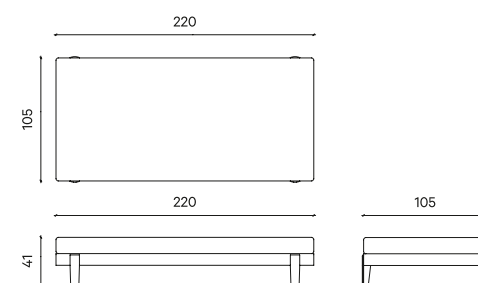

LAILAND BASE PENISOLA CM 130 P 130

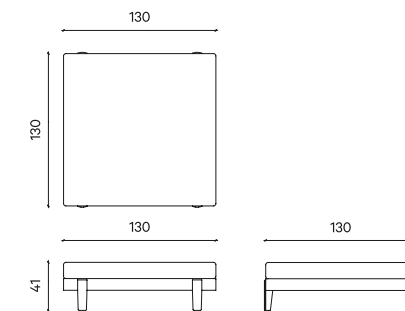

LAILAND BASE PENISOLA CM 160 P 130

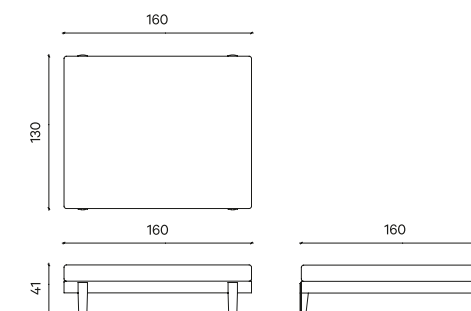

LAILAND SCHIENALE CM 88 H 25

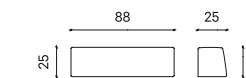

LAILAND SCHIENALE CM 118 H 25

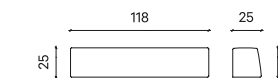

LAILAND SCHIENALE CM 148 H 25

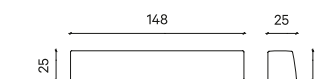

LAILAND SCHIENALE CM 178 H 25

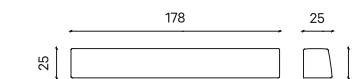

LAILAND SCHIENALE CM 208 H 25

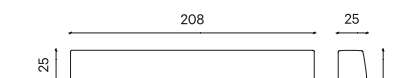

LAILAND SUPPORTO SCHIENALE CM 74 H 20

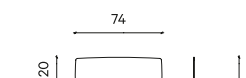

LAILAND SUPPORTO SCHIENALE CM 104 H 20

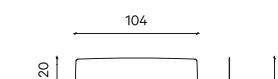

LAILAND SUPPORTO SCHIENALE CM 134 H 20

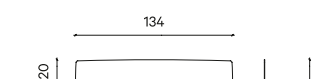

LAILAND SUPPORTO SCHIENALE CM 164 H 20

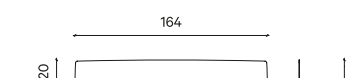

LAILAND SUPPORTO SCHIENALE CM 194 H 20

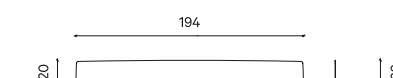

LAILAND SCHIENALE SPOSTABILE CM 88 H 25

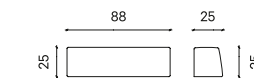

LAILAND SCHIENALE SPOSTABILE CM 118 H 25

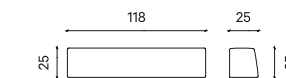

LAILAND CUSCINO SCHIENALE CM 50X50

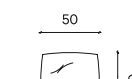

LAILAND CUSCINO SCHIENALE CM 70X50

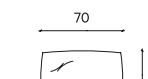

BRACCIOLO SPOSTABILE CENTRALE CM 75X37 H 8

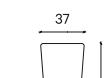

BRACCIOLO SPOSTABILE DX CM 80X37 H 8

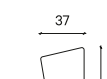

BRACCIOLO MSPOSTABILE SX CM 80X37 H 8



BRACCIOLO MSPOSTABILE SX CM 80X37 H 8

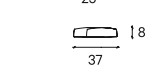

OPUS SOFA

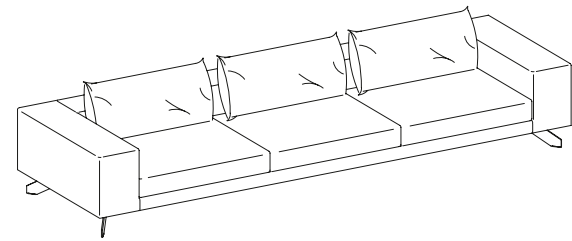

Seating system

Design
Massimo Castagna

STRUCTURE
Solid wood with suspension provided by elastic webbing.

PADDING
Polyurethane foam, covered with 100% goose down, internal cover in 100% white cotton lining. Seat cushion with high resilience variable density polyurethane foam covered with 100% quilted goose down. Internal cover in 100% white cotton. Back cushions padded with high density foam chips and polyester fiber. Internal cover 100% white cotton.

BASE
Steel hand burnished black.

FINISHES OF COVER AND PIPING
Fabric or leather from our samples catalogue. Leather version cover not removable.

DIMENSIONS
cm 110x85h
Seat cm 40h

NB Right/Rh and Left/Lh indicate the position of the armrest when facing the piece of furniture.

STRUTTURA
Legno listellare con molleggio tramite cinghiatura elastica.

IMBOTTITURA
In poliuretano espanso con densità variabile ricoperto con 100% piuma d'oca Bianca. Fodera 100% cotone spigato anti piuma bianco. Cuscino seduta in poliuretano espanso a densità variabile rivestito con 100% piuma d'oca Bianca. Fodera in 100% cotone spigato anti piuma bianco. Cuscino schienale con fibra di poliuretano espanso ad alta densità. Fodera in 100% cotone bianco.

BASE
In acciaio brunito nero.

FINITURE DI RIVESTIMENTO E BORDO
Tessuto e pelle nelle finiture a catalogo. Versione in pelle non sfoderabile.

DIMENSIONI
cm 110x85h
Seat cm 40h

NB Per SX/DX s'intende la posizione che il bracciolo assume guardando l'elemento frontalmente.

OPUS DIVANO 2 POSTI CM 260

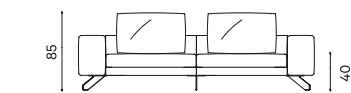
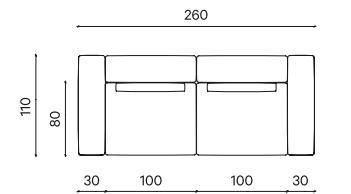

OPUS DIVANO 2 POSTI MAXI CM 320

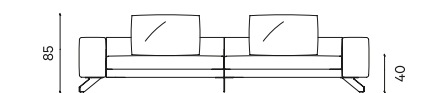
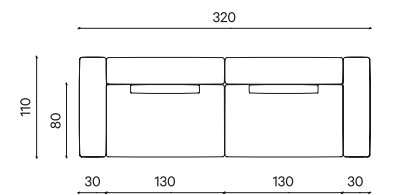

OPUS DIVANO 3 POSTI CM 360

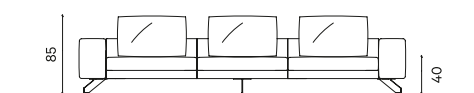
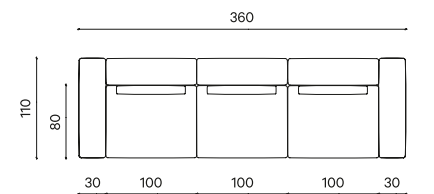

OPUS ELEMENTO 1 POSTO CM 130 DX

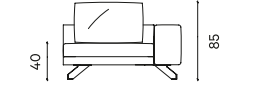
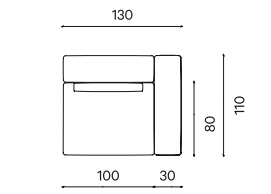

OPUS ELEMENTO 1 POSTO CM 160 DX

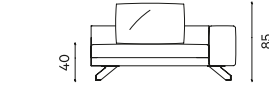
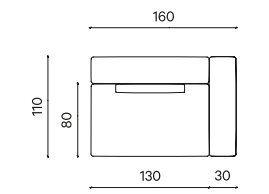

OPUS ELEMENTO 2 POSTI CM 230 DX

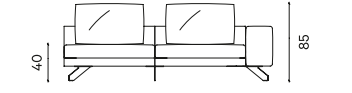
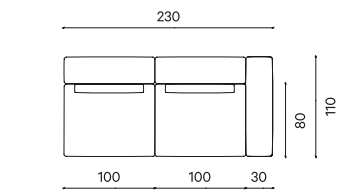

OPUS ELEMENTO 2 POSTI CM 290 DX

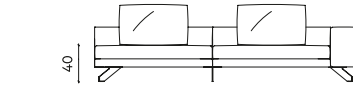
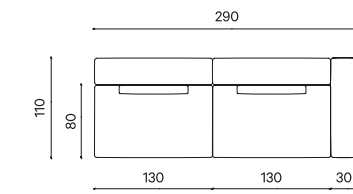

OPUS ELEMENTO 1 POSTO CM 130 SX

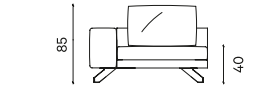
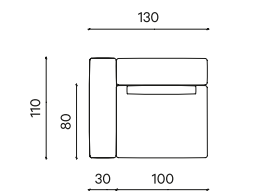

OPUS ELEMENTO 1 POSTO CM 160 SX

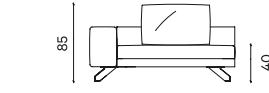
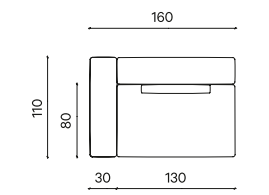

OPUS ELEMENTO 2 POSTI CM 230 SX

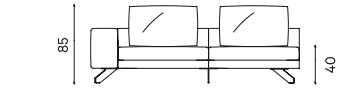
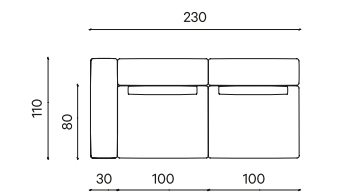

OPUS ELEMENTO 2 POSTI CM 290 SX

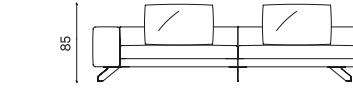
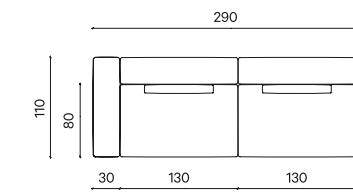

OPUS ELEMENTO CENTRALE CM 100

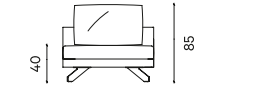
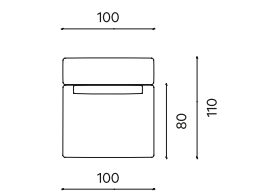

OPUS ELEMENTO CENTRALE CM 130

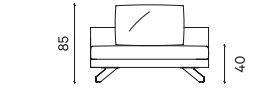
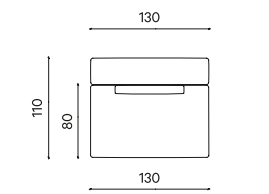

OPUS ISOLA CM 130 P 130

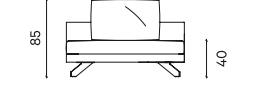
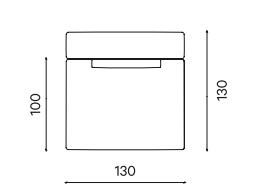

OPUS ISOLA CM 130 P 130 DX

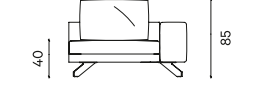
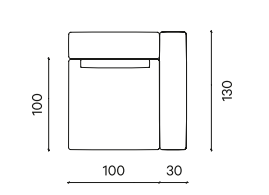

OPUS ISOLA CM 130 P 130 SX

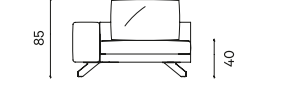
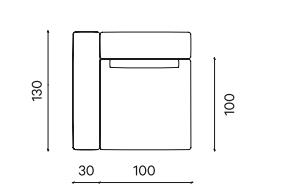

OPUS CONSOLLE INFILO CM 80X38

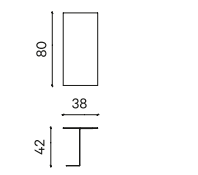

OPUS CONSOLLE INFILO CM 110X38

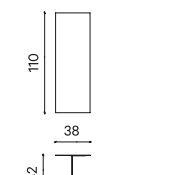

OPUS CONSOLLE INFILO CM 140X38

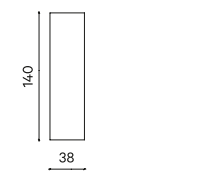

OPUS POUFF CM 100 P 80

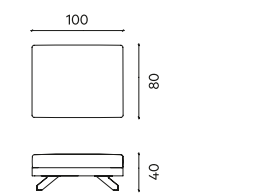

OPUS POUFF CM 130 P 80

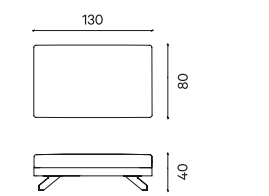

OPUS POUFF CM 160 P 80

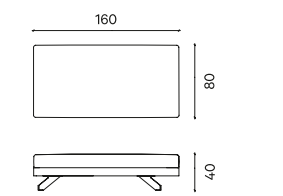

OPUS BRACCIOLO INFILO CM 60X30

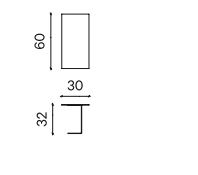

OPUS BRACCIOLO INFILO CM 80X30

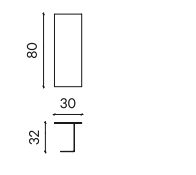

GELLY POUF

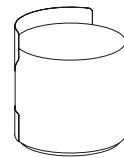

STRUCTURE

Solid wood with polyurethane foam in different density, covered with fabric or leather from our range. Cover not removable.

BACKREST

Metal structure padded with polyurethane foam and upholstered with leather from our range.

BASE

In black burnished Steel.

DIMENSIONS

Ø cm 43x50h swivel / Seat cm 43h
 Ø cm 43x43h / Seat cm 43h
 Ø cm 60x36h swivel / Seat cm 36h
 Ø cm 60x36h / Seat cm 36h

Design

Massimo Castagna

STRUTTURA

Legno listellare con imbottitura in poliuretano espanso a densità differenziate, rivestito con tessuto o pelle nella gamma a campionario. Non sfoderabile.

SCHIENALE

Struttura in metallo imbottito e rivestito con pelle nella gamma a campionario.

BASE

In acciaio brunito nero.

DIMENSIONI

Ø cm 43x50h / Seduta cm 43h
 Ø cm 43x43h / Seduta cm 43h
 Ø cm 60x36h swivel / Seat cm 36h
 Ø cm 60x36h / Seat cm 36h

GELLY POUFF ROTONDO C/SCHIENALE CM Ø 45

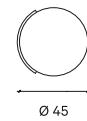
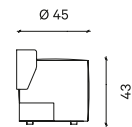

GELLY POUFF ROTONDO CM Ø 45

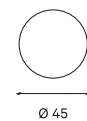
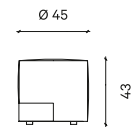

HEXAGON ARMCHAIR

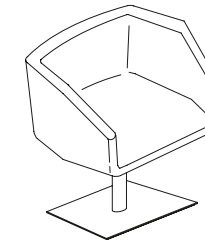

STRUCTURE

6 cm Ø metal tube and lower plate in steel base in finish burnished Brass. Swivel. Seat with wooden shell padded with polyurethane foam covered with leather or fabric from our samples catalogue. Cover not removable.

DIMENSIONS

cm 72x58x70h
 Seat cm 36h

Design

Massimo Castagna

STRUTTURA

Tubolare Ø 6 cm e base in acciaio finitura Ottone brunito. Girevole. Seduta con struttura in legno imbottita e rivestita in tessuto o pelle nella gamma dei colori a campionario. Non sfoderabile.

DIMENSIONI

cm 72x58x70h
 Seduta cm 36h

HEXAGON ARMCHAIR CM 72X58 H 70 - SEAT H 36

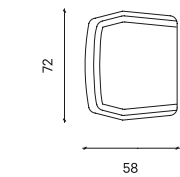
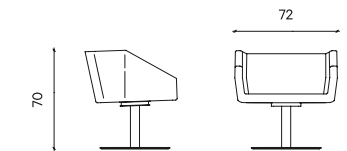

VOYAGE ARMCHAIR

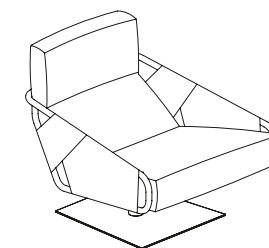

STRUCTURE

Ø 2,5 cm heavy duty curved steel pipe frame finish black burnished, burnished Titanio or burnished Platino, with woven laser cut thickness leather cat.400 E-Type or Durango. Seat padded and covered with leather or fabric from our range.

BASE FINISHES

6 cm Ø metal tube and lower plate in steel base. Swivel. Finish black burnished steel, burnished Titanio or burnished Platino.

DIMENSIONS

cm 80x80x74h / Seat cm 35h

Design

Massimo Castagna

STRUTTURA

Struttura in tubo metallico ad alta resistenza Ø 2,5 in finitura acciaio brunito nero, Titanio brunito o Platino brunito, con supporto in pelle intrecciata, categoria 400 E-Type con taglio a laser. Seduta e schienale imbottiti, rivestiti con tessuto o pelle nelle finiture a campionario.

BASE

Tubolare metallico 6 cm Ø e base in acciaio. Girevole. Finitura acciaio brunito nero, Titanio brunito o Platino brunito.

DIMENSIONI

cm 80x80x74h / Seduta cm 35h

VOYAGE ARMCHAIR CM 78X85 H 77 - SEAT H 37

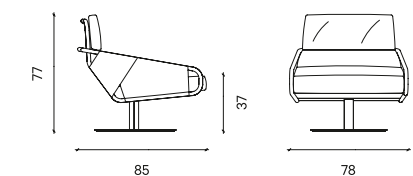

BE MINE XXL

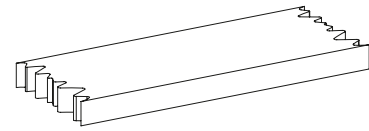

STRUCTURE

Mullion in sandcasting brass or Silver, base and top plate in shine brass or silver 0,5 cm thick.

DIMENSIONS

cm 160x70x20h
cm 180x70x20h

Design

Massimo Castagna

STRUTTURA

Struttura in ottone o Silver con fusione a terra, piani in ottone o H-Silver® lucido sp. 0,5 cm.

DIMENSIONI

cm 160x70x20h
cm 180x70x20h

BE MINE XXL CM 180X70 H 20

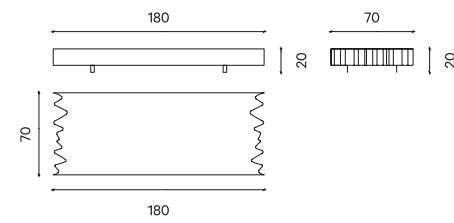

BE MINE XXL CM 160X70 H 20

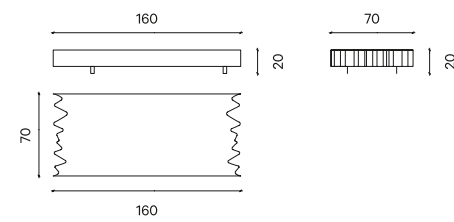

OCTAGON TABLE

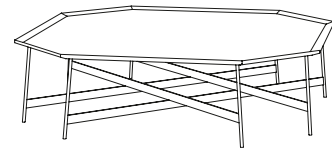

STRUCTURE

Structure 1 cm metal rod and shaped top in metal or stone from our range.

FINISH

Black burnished steel; Burnished Titanio; Burnished Platino; Burnished brass; Black burnished brass; H-silver. Stone top version with 2 cm shaped stone from our range.

DIMENSIONS

cm 40x40x50h
cm 70x70x40h
cm 90x90x30h
cm 120x120x30h (only with stone top)

Design

Massimo Castagna

STRUTTURA

Tondino 1 cm, top sagomato in lamiera o in pietra nelle finiture a campionario.

FINITURE

Acciaio brunito nero, Titanio brunito, Platino brunito, ottone brunito, ottone brunito nero, H-Silver®. Versione con top in pietra spessore 2 cm scavato e sagomato nelle finiture a campionario.

DIMENSIONI

cm 40x40x50h
cm 70x70x40h
cm 90x90x30h
cm 120x120x30h (solo con top in pietra)

OCTAGON TABLE MARBLE CM 120X120 H 30
OCTAGON TABLE CM 90X90 H 30

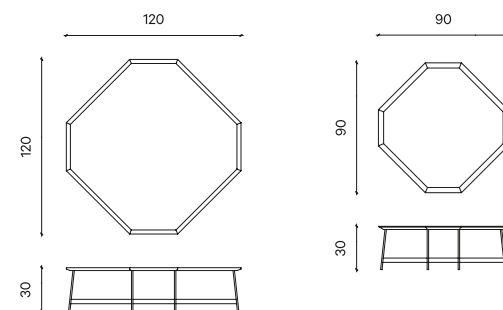

OCTAGON TABLE CM 70X70 H 30
OCTAGON TABLE CM 40X40 H 50

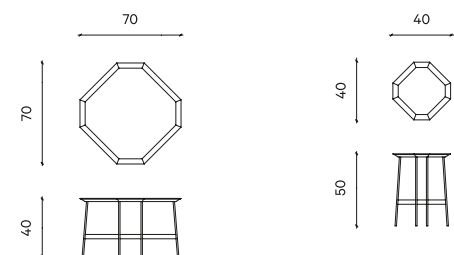

PRIMITIVE TABLE

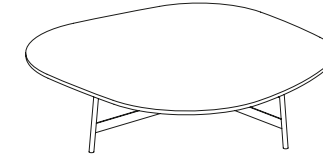

STRUCTURE

Structure 1,8 cm metal rod finish burnished Titanio, burnished Platino.

TOP

3 cm thickness White Ostuni stone.

DIMENSIONS:

cm 42x42x60h
cm 72x55x50h
cm 95x80x40h
cm 120x120x30h

Design

Massimo Castagna

STRUTTURA

Tondino diametro 8 cm in finitura Titanio brunito, Platino brunito. Versione con top in pietra nelle finiture a campionario.

TOP

Spessore 3 cm in pietra White Ostuni.

DIMENSIONI

cm 42x42x60h
cm 72x55x50h
cm 95x80x40h
cm 120x120x30h

PRIMITIVE TABLE CM 120X120 H 30
PRIMITIVE TABLE CM 95X80 H 40

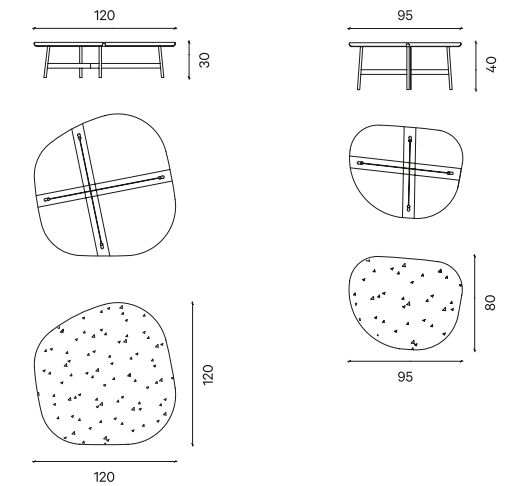

PRIMITIVE TABLE CM 72X55 H 50
PRIMITIVE TABLE CM 42X42 H 60

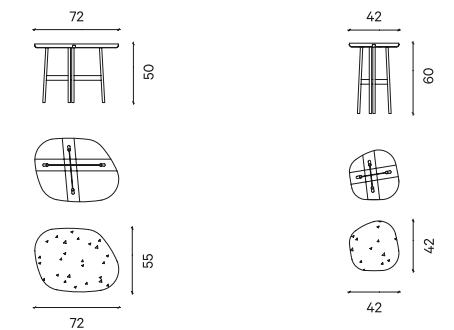

MUSHROOM TABLE

Design
George Yabu & Glenn Pushelberg

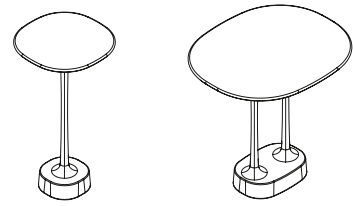

STRUCTURE
Mullion and top in sandcasting Brass, Bronze or Silver.

DIMENSIONS
cm 32x32x60h
cm 46x55x53h

STRUTTURA
Struttura in ottone, bronzo o argento con fusione a terra.

DIMENSIONI
cm 32x32x60h
cm 46x55x53h

MUSHROOM TABLE CM 32X32X60H

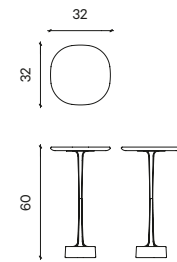

MUSHROOM TABLE CM 46X55X53H

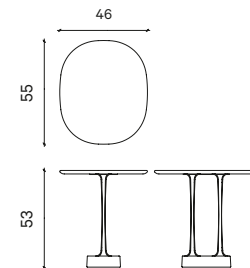

TWISTABLE COFFEE TABLE

Design
Massimo Castagna

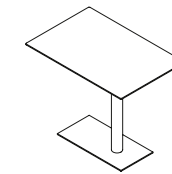

STRUCTURE
Support in sandcasting Brass, sandcasting Bronze, sandcasting Silver. With metal plate top and base in black steel finish: burnished Titanio, burnished Platino.

OPTIONAL
Stone top with stone from our range.

DIMENSIONS:
cm Ø 30x55h
cm Ø 40x45h
cm Ø 80x40h
cm 60x40x50h

STRUTTURA
Supporto in metallo con fusione a terra ottone, bronzo o Silver. Top e base in metallo in acciaio finitura Titanio brunito, Platino brunito.

OPTIONAL
Top in pietra nella gamma a campionario.

DIMENSIONI
cm Ø 30x55h
cm Ø 40x45h
cm Ø 80x40h
cm 60x40x50h

TWISTABLE CM 60X40 H 50
TWISTABLE CM Ø 80X80 H 40

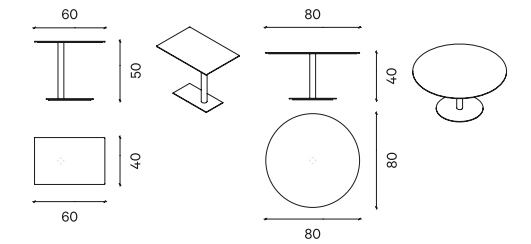

TWISTABLE CM Ø 40X45 H 50
TWISTABLE CM Ø 30X30 H 55

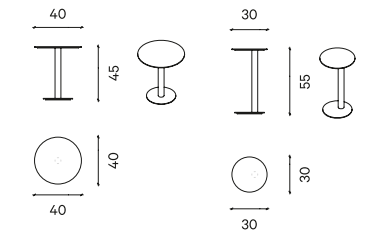

TWISTABLE CONSOLLE

Design
Massimo Castagna

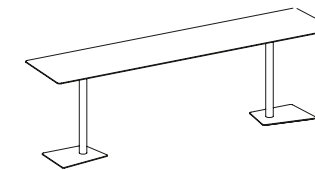

STRUCTURE
Support in sandcasting Brass, sandcasting Bronze, sandcasting Silver. With metal plate top and base in black steel finish: burnished Titanio, burnished Platino.

OPTIONAL
Stone top with stone from our range.

DIMENSIONS:
cm 175x45x65h
cm 199x45x80h

STRUTTURA
Supporto in metallo con fusione a terra ottone, bronzo o Silver. Top e base in metallo in acciaio finitura Titanio brunito, Platino brunito.

OPTIONAL
Top in pietra nella gamma a campionario.

DIMENSIONI
cm 175x45x65h
cm 199x45x80h

TWISTABLE CONSOLLE CM 199X45 H 80

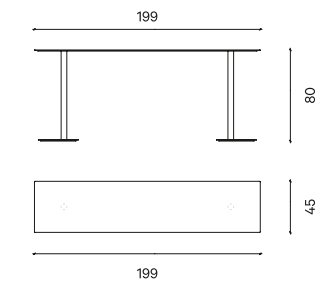

TWISTABLE CONSOLLE CM 175X45 H 65

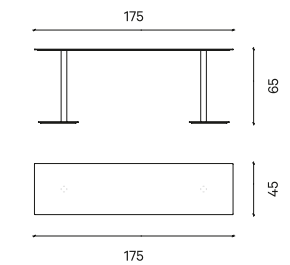

SAVANNAH

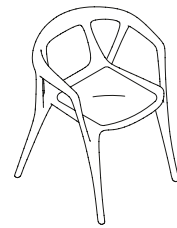

Dining chair

Design
Stephen Tierney

STRUCTURE

Wooden structure finish Black Wood or Gray Walnut, suspension provided by elastic webbing. Seat covered with leather from our samples catalogue. Cover not removable.

DIMENSIONS

Cm 58x54x74h
Seat cm 48h

STRUTTURA

Struttura in legno massiccio finitura Black Wood o Gray Walnut, molleggio tramite cinghiatura elastica. Seduta imbottita rivestita con pelle nella gamma a campionario. Non sfoderabile.

DIMENSIONI

Cm 58x54x74h
Seduta cm 48h

SAVANNA CHAIR CM 58X53 H 72

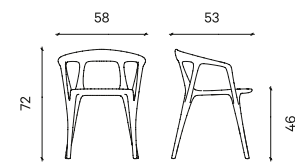

HEXAGON LOUNGE CHAIR

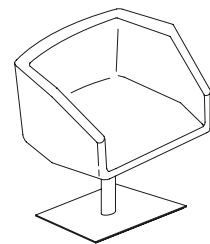

Design
Massimo Castagna

STRUCTURE

6 cm Ø metal tube and lower plate in steel base in finish burnished Brass. Swivel. Seat with wooden shell padded with polyurethane foam covered with leather or fabric from our samples catalogue. Cover not removable.

DIMENSIONS

cm 62x60x73h
Seat cm 40h

STRUTTURA

Tubolare Ø 6 cm e base in acciaio finitura Ottone brunito. Girevole. Seduta con struttura in legno imbottita e rivestita in tessuto o pelle nella gamma dei colori a campionario. Non sfoderabile.

DIMENSIONI

cm 62x60x73h
Seat cm 40h

HEXAGON LOUNGE CHAIR CM 62X60 H 73 - SEAT H 40

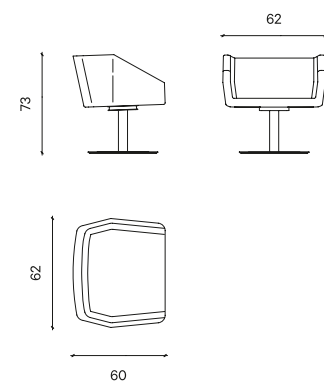

OXYMORON TABLE

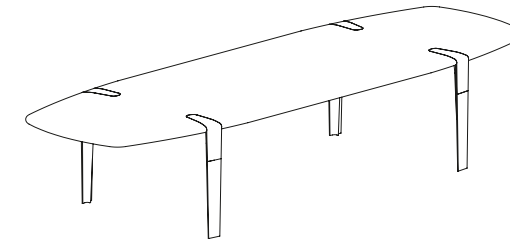

STRUCTURE

Steel frame with legs in sandcasting, bronze.

TOP

3 cm thickness solidwood Forest Fusion.

DIMENSIONS:

cm 330x120x75h
cm 350x120x75h
cm 380x120x75h
cm 240x110x75h
cm 240x160x75h
cm 270x110x75h
cm 300x160x75h

Design

Massimo Castagna

STRUTTURA

Struttura in acciaio con gambe in bronzo con fusione a terra.

TOP

In legno spessore 3 cm finitura Forest Fusion.

DIMENSIONI:

cm 330x120x75h
cm 350x120x75h
cm 380x120x75h
cm 240x110x75h
cm 240x160x75h
cm 270x110x75h
cm 300x160x75h

OXYMORON TABLE CM 380X120 H 75

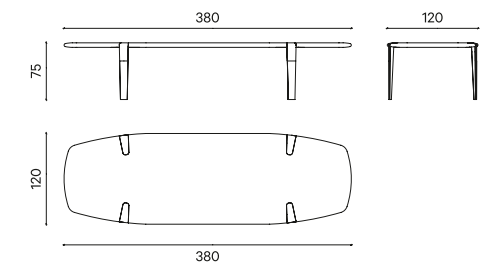

SCULPTURE TABLE

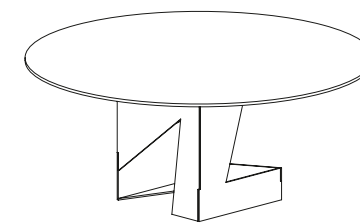

STRUCTURE

Structure in steel hand-burnished black.

TOP

1,5 cm glass H-Glass or extra clear glass.

DIMENSIONS:

cm Ø 180x75h

Design

Massimo Castagna

STRUTTURA

Struttura in acciaio brunito nero.

TOP

Vetro spessore 1,5 cm finitura H-Glass or extra chiaro.

DIMENSIONI

cm Ø 180x75h

SCULPTURE TABLE CM Ø 180 H 75

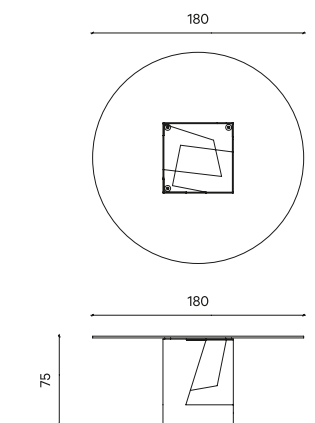

STARLIGHT LAMP

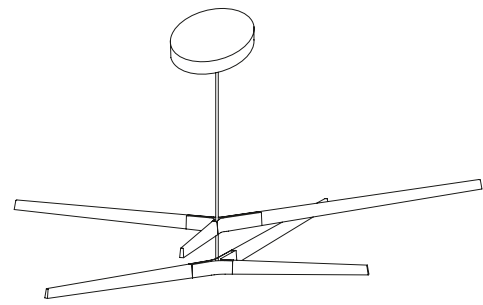

Dimmable pendant energy saving led lamp with Y-shaped central body sandcasting brass, sandcasting bronze or sandcasting Silver. Lighting body in burnished brass, black burnished brass, H-Silver. Pendant lamp, low voltage power supply cable inside the support tube. Energy efficiency index A. Transformer incorporated in the ceiling rosette (cm 22x6h). Standard overall height 100 cm adjustable. Can be customized. Available extra warm-white 2700K.

DIMENSIONS

cm 134x108x100h with downward pointing led, 54W, 3000K
cm 146x72x100h with downward pointing led, 54W, 3000K

Pendant energy saving led lamp

Design

Massimo Castagna

Lampada dimmerabile a risparmio energetica con corpo centrale a Y in ottone, bronzo o Silver con fusione a terra. Corpo illuminante in ottone brunito, ottone brunito nero, H-Silver. Sospensione con alimentazione a bassa tensione tramite cavi di sospensione. Classe energetica A. Trasformatori incorporate nel rosone (cm 22x6h). Altezza standard 100 cm regolabile. Personalizzabile a richiesta. Disponibile luce extra calda 2700K (senza sovrapprezzo).

DIMENSIONI

cm 134x108xXh led con puntamento verso il basso, 54W, 3000K
cm 146x72xXh led con puntamento verso il basso, 54W, 3000K

STARLIGHT HORIZONTAL

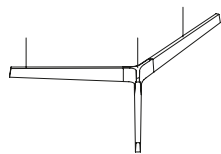

Dimmable pendant energy saving led lamp with Y-shaped central body sandcasting brass, sandcasting bronze or sandcasting Silver. Lighting body in burnished brass, black burnished brass, H-Silver. Pendant lamp, low voltage power supply cable through suspension cable. Energy efficiency index A. Transformer incorporated in the ceiling rosette. Standard overall height 180 cm adjustable. Can be customized. Available extra warm-white 2700K.

DIMENSIONS

cm 134x108x6h with downward pointing led, 27W, 3000K
cm 146x72x6h with downward pointing led, 27W, 3000K
cm 149x94x6h with downward pointing led, 27W, 3000K

Lampada dimmerabile a risparmio energetico con corpo centrale a Y in ottone, bronzo o Silver con fusione a terra. Corpo illuminante in ottone brunito, ottone brunito nero, H-Silver. Sospensione con alimentazione a bassa tensione tramite cavi di sospensione. Classe energetica A. Trasformatori incorporate nel rosone. Altezza standard 180 cm regolabile. Personalizzabile a richiesta. Disponibile luce extra calda 2700K (senza sovrapprezzo).

DIMENSIONI

cm 134x108x6h led con puntamento verso il basso, 27W, 3000K
cm 146x72x6h led con puntamento verso il basso, 27W, 3000K
cm 149x94x6h led con puntamento verso il basso, 27W, 3000K

STARLIGHT CM 175X85

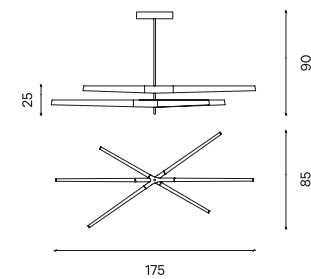

STARLIGHT CM 173X110

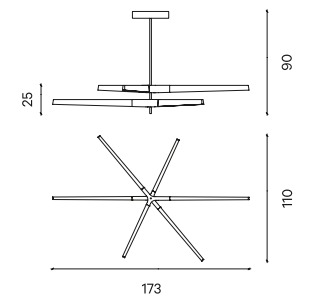

STARLIGHT HORIZONTAL CM 134X108

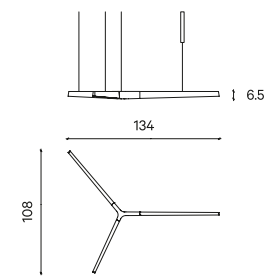

STARLIGHT HORIZONTAL CM 146X72

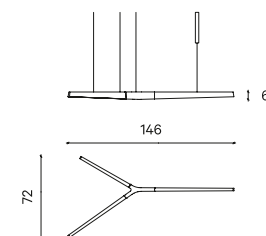

STARLIGHT HORIZONTAL CM 149X94

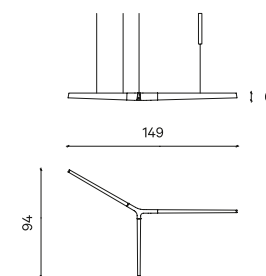

STARLIGHT HORIZONTAL XL

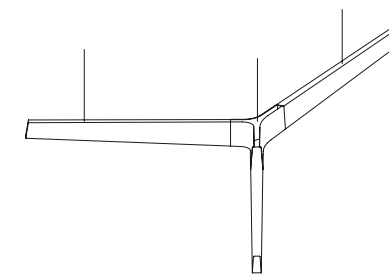

Dimmable pendant energy saving led lamp with Y-shaped central body sandcasting brass, sandcasting bronze or sandcasting Silver. Lighting body in burnished brass, black burnished brass, H-Silver. Pendant lamp, low voltage power supply cable through suspension cable. Energy efficiency index A. Transformer incorporated in the ceiling rosette. Standard overall height 180 cm adjustable. Can be customized. Available extra warm-white 2700K.

DIMENSIONS

cm 262x147x8h with downward pointing led, 53W, 3000K
cm 311x126x8h with downward pointing led, 53W, 3000K
cm 305x156x108x8h with downward pointing led, 53W, 3000K

Pendant energy saving led lamp

Design

Massimo Castagna

Lampada dimmerabile a risparmio energetico con corpo centrale a Y in ottone, bronzo o Silver con fusione a terra. Corpo illuminante in ottone brunito, ottone brunito nero, H-Silver. Sospensione con alimentazione a bassa tensione tramite cavi di sospensione. Classe energetica A. Trasformatori incorporate nel rosone. Altezza standard 180 cm regolabile. Personalizzabile a richiesta. Disponibile luce extra calda 2700K (senza sovrapprezzo).

DIMENSIONI

cm 262x147x8h led con puntamento verso il basso, 53W, 3000K
cm 311x126x8h led con puntamento verso il basso, 53W, 3000K
cm 305x156x108x8h led con puntamento verso il basso, 53W, 3000K

STARLIGHT HORIZONTAL XL CM 262X174

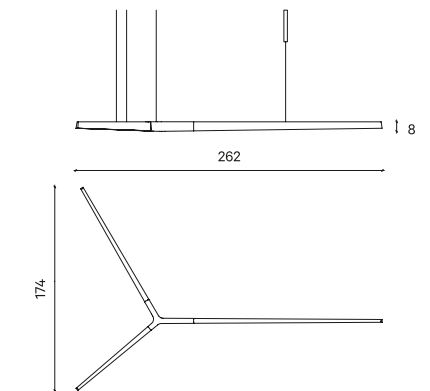

STARLIGHT HORIZONTAL XL CM 305X156

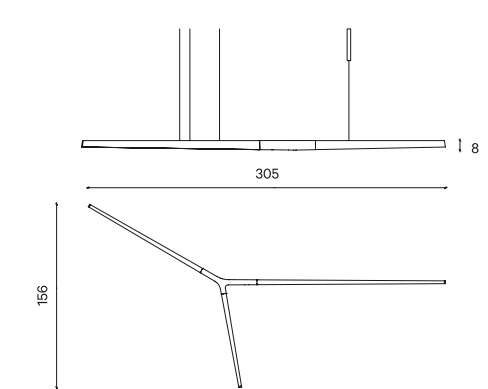

STARLIGHT HORIZONTAL XL CM 311X126

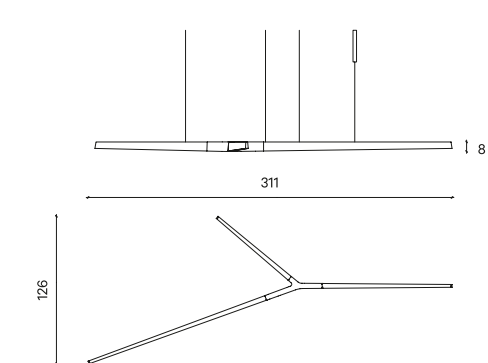

REFLEX

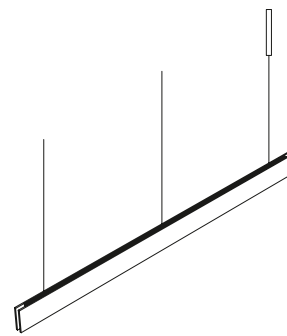

Pendant energy saving led lamp with body h20 cm covered with burnished steel mesh tweed pattern or burnished brass. Body h 15 cm in white quartz stone. Low voltage power supply cable through suspension cable. Energy efficiency index A. Transformer incorporated in the ceiling rosette. Only for indoor use. Standard overall height 180 cm adjustable. Can be customized. Dimmable upon request. Standard overall height 180 cm adjustable. Can be customized. Available extra warm-white 2700K (without extra cost).

DIMENSIONS
cm 100x4 (4,5 White Quartz) with downward pointing led, 13W, 3000K
cm 200x4 (4,5 White Quartz) with downward pointing led, 28W, 3000K

Design
Massimo Castagna

Lampada a sospensione a led (classe energetica tipo A) con corpo lampada h20 cm rivestito con rete metallica o in ottone brunito. Corpo lampada h 15 cm nella versione in pietra White Quartz. Alimentazione a bassa tensione realizzata tramite cavi di sospensione. Trasformatore inserito nel rosone. Dimmerabile su richiesta. Altezza standard 180 cm regolabile, personalizzabile. Disponibile luce extra calda 2700K (senza sovrapprezzo).

DIMENSIONI
cm 100x4 (4,5 White Quartz) led rivolti verso il basso, 13W, 3000K
cm 200x4 (4,5 White Quartz) led rivolti verso il basso, 28W, 3000K

OOPS LIGHT

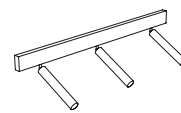

Ceiling or wall energy saving led sconce, brass tubes diameter 4 finish burnished brass or black burnished brass. Sconce with brass wall supports 100 cm. Led bulb, energy efficiency index A. Only for indoor use. Available extra warm-white 2700K (without extra cost).

DIMENSIONS
Ø cm 4x70h (canopy 100 cm) 24W, 3000K

Design
Isabella Genovese

Lampada a soffitto o parete, corpo luce diametro 4 cm in ottone brunito o ottone brunito nero, barra elettrificata in ottone 100 cm. Lampadina led, classe energetica A. Solo per uso interno. Disponibile con luce extra calda 2700K (senza sovrapprezzo).

DIMENSIONI
Ø cm 4x70h (rosone 100 cm) 24W, 3000K

REFLEX LIGHT 100

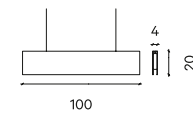

REFLEX LIGHT 200

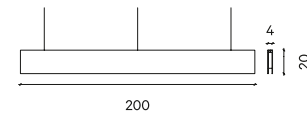

REFLEX MARBLE LIGHT 100

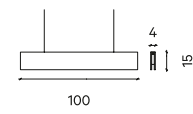

REFLEX MARBLE LIGHT 200

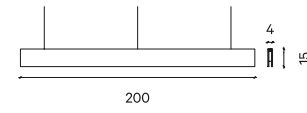

OOPS LIGHT CM 100 Ø 4

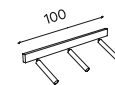

ELBUS LAMP

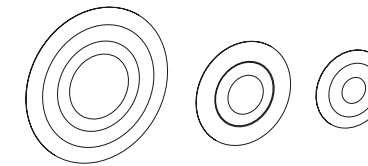

Wall energy saving led sconce with warm light (energy efficiency index A), with structure in oak solidwood; transformer incorporated in the lamp. Dimmable upon request.

DIMENSIONS
Frame Ø 60 (20cm lamp)x6th cm, 16W, 2700K
Frame Ø 80 (30cm lamp)x6th cm, 24W, 2700K
Frame Ø 120 (50cm lamp)x6th cm, 38W, 2700K

Design
Massimo Castagna

Lampada a parete a led basso consumo (classe energetica tipo A) con luce calda. Struttura in rovere massello; trasformatore incorporato nella lampada. Dimmerabile su richiesta.

DIMENSIONI
Cornice Ø 60 (20cm luce)x6sp cm, 16W, 2700K
Cornice Ø 80 (30cm luce)x6ps cm, 24W, 2700K
Cornice Ø 120 (50cm luce)x6sp cm, 38W, 2700K

ELBUS LAMP Ø CM 60

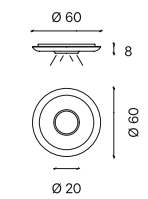

ELBUS LAMP Ø CM 80

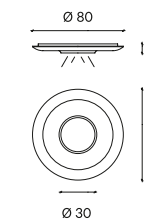

ELBUS LAMP Ø CM 120

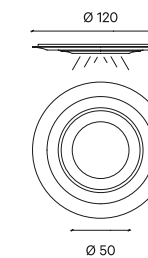

GHOST LAMP TABLE

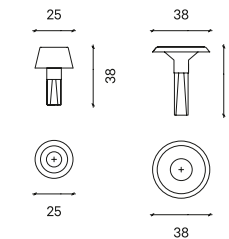

GHOST LAMP TABLE

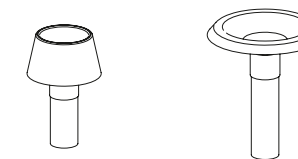

Table lamp with COB led bulb (energy efficiency index A) energy saving with warm light. Central element in resin, in transparent or gray colour, diameter 9 cm. Light diffuser in black burnished steel, burnished Titano, burnished Platino, burnished brass, black burnished brass or H-Silver. Available extra warm-white 2700K.

DIMENSIONS
Ø cm 25x38h, 4W, 3000K
Ø cm 38x45h, 4W, 3000K

Design
Massimo Castagna

Lampada da tavolo con lampadina led COB (classe energetico tipo A) luce calda. Corpo canterale in resina nei colori trasparente e grigio, diametro 9 cm. Paralume in acciaio brunito nero, Titano brunito, Platino brunito, ottone brunito, ottone brunito nero o H-Silver®. Disponibile luce etra calda 2700K.

DIMENSIONS
Ø cm 25x38h, 4W, 3000K - 380Lm¹
Ø cm 38x45h, 4W, 3000K - 380Lm¹

NOCTIS BED

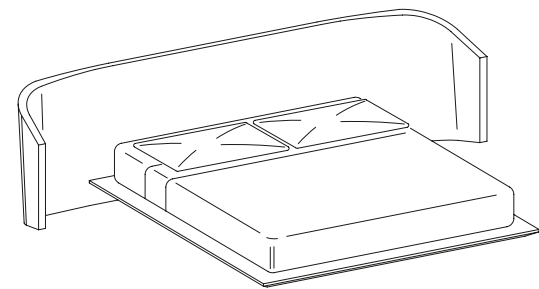

Bedframe structure and headboard in solid wood padded with polyurethane foam, upholstered with fabric or leather from our range. Headboard back panel covered with fabric or leather from our range or in burnished brass.

DIMENSIONS
cm 305x220x90h

Design
Massimo Castagna

Gioiletto e testiera con struttura in legno listellare imbottito con poliuretano espanso rivestito con tessuti e pelle nelle finiture a campionario. Pannello retroletto rivestito in tessuto o pelle nelle finiture a campionario o in ottone brunito.

DIMENSIONI
cm 305x220x90h

TOWER TALL CHEST

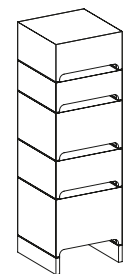

STRUCTURE
2,5 cm multilayer wood with inserts in burnished brass. Drawer with soft closing concealed drawers guides.

FINISHES
Heat treated eucalyptus, Black Eucalyptus, Acacia, Oak, swamp Oak or swamp Elm.

DIMENSIONS
cm 45x45x144h

Design
Massimo Castagna

STRUTTURA
In legno listellare spessore 2,5 cm con inserti in ottone brunito. Cassetteria con guide a scomparsa soft closing.

FINITURE
Legni termizzati: eucalipto, eucalipto nero, rovere, acacia o rovere di palude e olmo di palude.

DIMENSIONI
cm 45x45x144h

LETTO NOCTIS CM 305X220

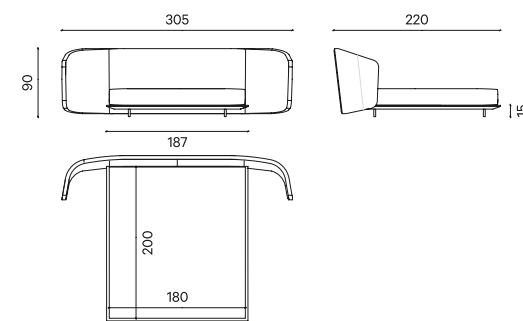

TWISTABLE CONSOLLE NIGHT STAND

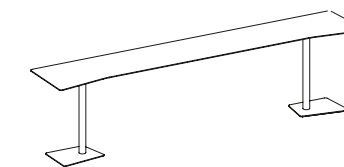

STRUCTURE
Support in sandcasting Brass, sandcasting Bronze, sandcasting Silver. Metal plate in steel finish burnished Titanio, burnished Platino.

OPTIONAL
Stone top with stone from our range.

DIMENSIONS
254x44x65h shaped top

Design
Massimo Castagna

STRUTTURA
Supporto in metallo con fusione a terra ottone, bronzo o Silver. Top e base in acciaio finitura Titanio brunito, Platino brunito.

OPTIONAL
Top in pietra nella gamma a campionario.

DIMENSIONI
254x44x65h top sagomato

TWISTABLE CONSOLLE NIGHTSTAND

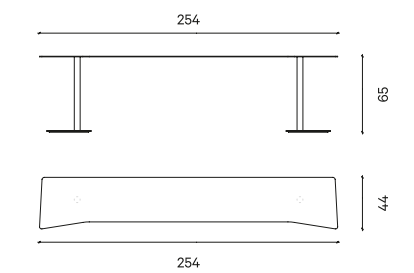

NOCTIS TOWER 5 CASSETTI CM 45X45 H 144

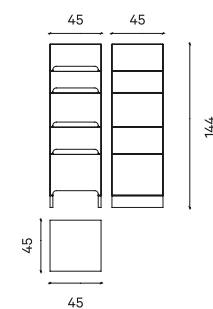

NOCTIS SLIM VERTICAL

Design
Massimo Castagna

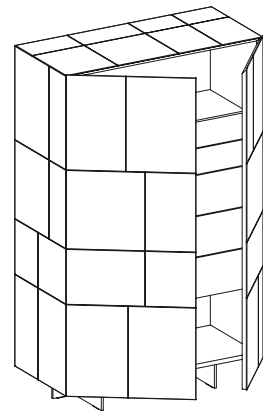

STRUCTURE

Structure and doors in 2,5 cm thick solid wood black eucalyptus thermowood – oil finish veneer.

FINISH

Burnished Brass, scratched brass, H-Silver, scratched H-Silver, Silver patina.

DRAWER UNIT

Structure in 2,5 cm thick solid wood black eucalyptus thermowood – oil finish veneer, with top in extra clear glass. 1st drawer with internal partition in burnished steel and bottom in E-Type black leather. Push-pull opening. Internal backrest in bronzed mirror.

BASE

Black burnished steel cm 12h
Mandatory wall attachment kit included.

OPTIONAL

Natural led light kit 3000K flush with the top of the cabinet.

DIMENSIONS

cm 100x45x163h

STRUTTURA

Struttura e ante in legno listellare sp. 2,5 cm finitura eucalypto nero termizzato – finite ad olio e cera ad acqua.

FINITURE

Ottone Brunito, ottone graffiato, H-Silver®, H-Silver® graffiato, Silver Patina.

CASSETTIERA INTERNA

Struttura in legno listellare spessore 2,5 cm finitura eucalypto nero termizzato- finite ad olio e cera ad acqua, con top in vetro extra chiaro. Primo cassetto con partizione interna in acciaio brunito nero, fondo in pelle E-Type nero. Apertura push-pull. Schianale interno in specchio bronzato.

BASE

Acciaio bonito nero 12 cm h
Fissaggio a muro obbligatorio.

OPTIONAL

Kit luce led naturale 3000K con accensione ad aperture ante.

DIMENSIONI

cm 100x45x163h

NOCTIS SLIM VERTICAL CM 100X45 H 163

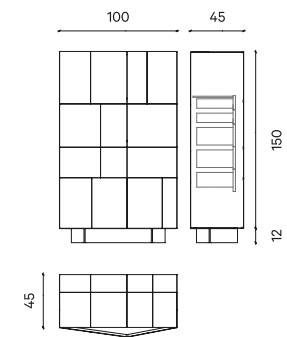

NOCTIS VANITY

Design
Massimo Castagna

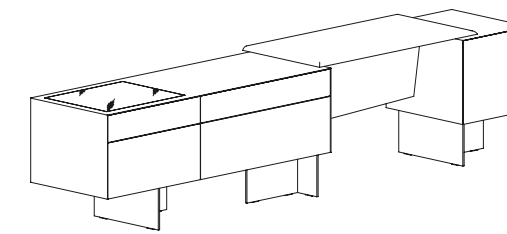

STRUCTURE:

Structure and doors in solid wood. Desk in massive oak wood or covered with black burnished steel or leather from our range. Outside covered with black burnished steel, burnished Titanio, burnished Platino, burnished brass, black burnished brass, scratched brass, H- Silver, Silver Patina. Drawers unit in solid wood black eucalyptus thermowood – oil finish veneer, with top in extra clear glass. 1st drawer with internal partition in burnished steel and bottom in E-Type black leather. Push-pull opening. Storage unit in solid wood black eucalyptus thermowood – oil finish veneer, with shelve bronzed tempered glass thickness 1 cm.

BASE

In black burnished steel h 25 cm.

DIMENSIONS

cm 320x60x75h

Sizes can be customized.

STRUTTURA

Struttura e ante in legno listellare. Piano scrivania in rovere massiccio oppure rivestito in acciaio brunito nero o nelle pelli della gamma a campionario. Struttura esterna rivestita in acciaio brunito nero, Titanio brunito, Platino brunito, ottone brunito, ottone brunito nero, ottone graffiato, H-Silver, Silver Patina. Blocco cassetiera in legno listellare finitura eucalypto nero termizzato – finitura ad olio, con top in vetro extra chiaro. Primo cassetto con partizioni interne in acciaio brunito nero e fondo in pelle E-Type nero. Apertura push-pull. Blocco contenitore in legno listellare finitura eucalypto nero termizzato – finitura ad olio, ripiano interno in vetro temperato bronzato spessore 1 cm.

BASE

In acciaio brunito nero h 25 cm.

DIMENSIONI

cm 320x60x75h

Personalizzabile a disegno

NOCTIS VANITY CM 320X60 H 75

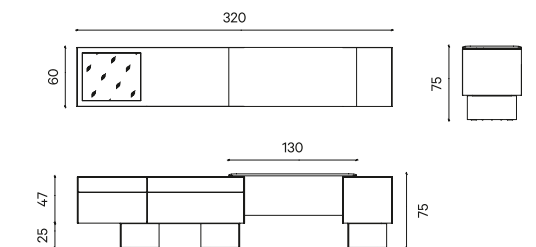

FINISHES

CHAPTER 1

BE MINE Sandcasting Brass, Sandcasting Silver
BISTROT S Burnished Platino
CAGE B WINE STORAGE Structure Black
Burnished brass, Shelves Black eucalyptus
thermowood, Wine support Shine copper
ELBUS LAMP Oak thermowood
EX-TRA CHAIR Leather Nabuk Slate 90
FRAME CABINET Drama brass
GALAXY MAXI COFFEE TABLE Black burnished brass
GELLY POUF Fabric Rubelli Ombra 218,
Leather Sense 18, Leather Nabuk Terra 91,
Base Black burnished steel
GHOST TABLE LAMP Burnished brass,
Transparent resin
HUMAN SOFA Fabric Delirium 61,
Leather Camoscio 36, Loose cushions: Axum 30,
Rubelli Ombra 202, Leather Nabuk Terra 91
LAILAND SOFA Fabric Axum 23 , Leather Nabuk 28,
Legs Sandcasting Bronze, Loose cushions Caruso
10/1652, Caruso 10/1654
LIGHT RING HORIZONTAL Burnished brass
LOOM FR Burnished Brass, Black Eucalyptus
thermowood
LOOM PROGRAM Sides and base in Black
burnished steel, shelves and storage units in
Swamp oak, backrest in Burnished Titanio,
Door frame in Black burnished steel
MUSHROOM Sandcasting Brass,
Sandcasting Silver
OCTAGON Stone top Web Gray, Structure Black
Burnished Brass
OPUS SOFA Leather Sense 18, Legs Black
burnished Steel, Loose cushions: Axum 26,
Axum 11, Rubelli Ombra 218, Opus slip consolle
and Slip Armrest E-Type testa di moro 3436
OZONE L Top in White cristal, Structure in Black
Copper high pressure
PIPE LIGHT S Burnished brass
PRIMITIVE TABLE Top white Ostuni, Structure
Burnished Titanio
REFLEX LAMP White quartz, Burnished brass

SAETTA TABLE Top Black Lake,
Legs Sandcasting Bronze
SAVANNA CHAIR Leather Nabuk Slate 90,
Black Wood
SCULPTURE TABLE Top H-Glass,
Black burnished steel
SIDE X EVO Structure in Silver Patina,
Top in Cappuccino microsandblasted stone,
Base in Black burnished steel
STARLIGHT HORIZONTAL XL Sandcasting Brass,
Burnished Brass
STARLIGHT LAMP Sandcasting Bronze,
Black burnished brass
STILE SET Black Eucalyptus thermowood,
Black burnished brass, Burnished Titanio
STRIP CHAIR Leather Nabuk Ibisco 34,
Black burnished steel
TANGRAM BOOKSHELF Burnished brass
TAPE LIGHT PAIR H-Silver black
TAPE LIGHT WALL Burnished brass
TELE LIGHT Burnished Brass
TOUCH COFFEE TABLE Top oak thermowood,
Structure Burnished Titanio
TWISTABLE Ø 30 Top and base Burnished Titanio,
Support Sandcasting bronze
TWISTABLE 60X40X50H Stone top Black Lake,
Support Sandcasting Bronze, Base Burnished Titanio
TWISTABLE CONSOLLE Top and base in
burnished brass, Support in sandcasting brass
TWISTABLE Ø 80 Top and base in Burnished
Titanio, Support in Sandcasting Bronze
VOYAGE ARMCHAIR Leather E-Type testa di
moro 3436, Fabric Axum 26, Structure in Black
burnished steel
WALL CLIP Shine Silver

CHAPTER 2

BE MINE Sandcasting Silver
BE MINE XXL Sandcasting Silver, shine silver
BISTROT S Burnished Titanio
ELBUS LAMP Oak thermowood
GELLY POUF Fabric Axum 23, Leather Nabuk 28,
Leather Sense 18, Base Black burnished steel
GHOST TABLE LAMP Black burnished steel,
transparent resin; Burnished Platino, Gray resin
HEXAGON ARMCHAIR Leather Nabuk Ibisco 34,
base Burnished Titanio
HEXAGON LOUNGE Leather E-Type testa di moro
3436, structure in finish burnished brass
LAILAND SOFA Fabric Axum 23, Leather Nabuk
Moss, Legs sandcasting brass, Loose cushions:
Caruso 10/654, Caruso 10/1652, Rubelli Ombra 218,
Axum 23
LIGHT RING POLYGONAL Burnished Platino
LOOM PROGRAM Sides and base in Black
burnished steel, shelves Black eucalyptus, Backrest
in Black lake stone, Tv panel in black burnished
steel, Door frame in Black burnished brass
MUSHROOM Sandcasting Silver
OCTAGON TABLE Stone top Black lake,
Burnished brass
OPUS SOFA Fabric Dedar KK Antracite 5, Leather
Nabuk 28, slip armrest Sense 18, Legs Black
burnished steel, Loose cushions: Nabuk Bordeaux
35, Axum 11, Nabuk Ibisco 34, Nabuk Slate 90
OXYMORON TABLE Top Forest Fusion Wood,
Legs Sandcasting Bronze
PRIMITIVE TABLE Top white Ostuni, Structure
Burnished Titanio
SAVANNA CHAIR Leather Nabuk Slate 90,
Black Wood
SHIFT TABLE Top in Black Lake stone,
Base in Black burnished steel
SIDE X EVO HIGH Structure in Silver Patina,
Top in Cappuccino microsandblasted stone,
Base in Black burnished steel
STARLIGHT HORIZONTA XL Sandcasting Bronze,
Black burnished brass

STARLIGHT LAMP Sandcasting Bronze,
Black burnished brass
TAPE LIGHT PAIR H-Silver black
TOUCH COFFEE TABLE Top oak thermowood,
Structure Burnished Titanio
TWISTABLE Ø 80 Top and base Burnished Titanio,
Support Sandcasting bronze
TWISTABLE 60X40X50H Top and base Burnished
Titanio, support Sandcasting Bronze
TWISTABLE CONSOLLE Top and base in
burnished brass, Support in sandcasting brass
TWISTABLE Ø 30 Stone top Cappuccino
microsandblasted, support Sandcasting Bronze,
Base Burnished Titanio
VOYAGE ARMCHAIR Leather E-Type testa di moro
3436, Seat leather Nabuk 28, Structure in Black
burnished steel
W-TABLE Top Big Marinace, Structure Black
burnished steel

CHAPTER 3

GELLY POUF Fabric Axum 30, Backrest Leather
Nabuk Stone 17, Leather Nabuk Terra 91 ,
Base in black burnished steel
GHOST TABLE LAMP Black burnished steel,
transparent resin; Burnished Platino, Gray resin
HEXAGON ARMCHAIR Leather Nabuk Terra 91,
Base Burnished Titanio
LAILAND SOFA Leather Nabuk Stone 17,
Fabric Axum 30, Camoscio 36, Legs Sandcasting
Silver, Loose cushions: Rubelli Ombra 208,
Rubelli Ombra 202
NOCTIS BED Leather Nabuk 28, Burnished Brass
NOCTIS CHEST OF 5 DRAWERS Black eucalyptus
thermowood
NOCTIS VANITY Structure silver Patina, Base and
desktop Black burnished steel
PIPE LIGHT L Burnished brass
PIPE LIGHT S Burnished brass
PRIMITIVE TABLE Top white Ostuni, Structure
Burnished Titanio
STARLIGHT HORIZONTAL XL Sandcasting Silver,
H-Silver
TWISTABLE CONSOLLE NIGHT STAND Top and base
in Burnished Platino, Support in sandcasting brass
TWISTABLE Ø 40 Top and base Burnished Platino,
support Sandcasting Bronze

CONCEPT, ART DIRECTION
Massimo Castagna - AD Architettura

PHOTO ART DIRECTION
Massimo Castagna - AD Architettura

PHOTO
Andrea Pancino
Mattia Pasin

STYLING
Elena Caponi Studio

GRAPHIC DESIGN
Gusto IDS

PRINTING
Grafiche Antiga



June 2018



THANKS TO
Alberto Mariani
Alexa Lixfeld
Charlotte Jankowski
Claire Frechet
Fabio Vogel
Inderjeet Sandhu
Jeremie Duprey
Matthias Kaiser
Sara Ricciardi

WORKS OF ART COURTESY OF
Esh Gallery
Osart Gallery

HENGE
Via della Spiga 7
20121 Milano (MI) - Italy
Tel. +39 0438 1710600 - Fax +39 0438 1710113
www.henge07.com . atelier@henge07.com
Open by appointment



Offices and Factory
Via G. Verdi, 45
31010 Farra di Soligo (TV) - Italy

