

GERVASONI™

BRICK
CROSS
MIK
MOON
MORE
UP





MOON
UP
BRICK
CROSS
KIM
MORE

design
PAOLA NAVONE



UP 28

Urban green





BRICK 97



BRICK 96



BRICK 99



BRICK 98



MIK 12



BRICK 247



INOUT 43





UP 28

BRASS 47



MORE 07 L, 21 AN, 06, 22 R

BRICK 244

BOLLA L

INOUT 44

CARVE 07

BRICK 241

BRICK 248

LOG L, S

BRICK 242



BRICK 244

MORE 08 P

BOLLA L



INOUT 44



MORE 07 L, 21 AN, 06, 22 R

BOLLA L

INOUT 44

BRICK 244



LOG L, S

BRICK 242



MORE 08 P



BRICK 241



BRICK 248



CARVE 07



SWEET 95

BRICK 133

BRICK 23



BRICK 133

BRICK 23



BRASS 95

BRICK 215

BRICK 233

BRICK 221

INOUE 48



SPIN 95

GRAY 45

BRICK 241

NEXT 998

UP 80 E

CARVE 07

Hard and soft



BRICK 247, 248

MORE 07 L

MORE 22 R



BRICK 247, 248

NEXT 142

BRICK 242

BRICK 247, 248

NEXT 999

BRICK 312

MORE 07 L, 22 R

NEXT 998



NEXT 141

CARVE 07



BRICK 67



NEXT 142



MORE 12



BRICK 97

BRICK 67



BRICK 305

BRICK 242



SWEET 91

UP 23

BRASS 44





ALLU 223 I

BRICK 231

ALLU 224 I



BRICK 228





BRICK 233

ALLU 223 I



BRICK 99

BRICK 65



BRICK 51

BRICK 242

UP 80 E

NEXT 999

Poetic place



CROSS 42



BRICK 98



BRICK 312



CROSS 42



CROSS 46





CROSS 42

MIK 10

CROSS 46



BRICK 242

BRICK 309

BRICK 241



MORE 24 P



BRICK 309

MORE 24 P

BRICK 244

BRICK 242, 241



BRICK 223

BRICK 85





CROSS 71



BRICK 215



BRICK 80 E

CROSS 42



BRICK 307



CROSS 44

MORE 25



White white white



BRICK M, S



BRICK 241



NUVOLA 05



LOG S



MORE 08 P



BRICK M

MIK 12

BRICK 248, 247



BRICK 247

BRICK 248



MIK 12

BRICK S, M, XS, L



BRICK 63

GRAY 23

NEXT 232



BRICK XS

NEXT 232

UP 23





MORE 20 L

MORE 06

MORE 22 R

LOG S, M, L

BRICK 248

BRICK 247

BRICK 241

NEXT 999



MORE 20 L, 06, 22 R

LOG S, M, L

BRICK 247, 248

MORE 08 P

NEXT 999



BRICK 33

GHOST 23



BRICK 68



SWEET 91

BRICK 241, 244

BRICK 80 E

BRICK 63

BRICK S

BRICK M

BRICK XS

BRICK L



BRICK 51

Black and blues



BRICK 247



BRICK 241

NEXT 999

NEXT 18



BRICK 247

BRICK 242

NEXT 18

BRICK 241

NEXT 999



NUVOLA 05

BRASS 43



BRASS 45

MOON 42

NEWS 108



MORE 07 L

MORE 06

MORE 22 R

BRASS 95

BRICK 244

MOON 42

BRASS 45

BRICK 18

BRICK 241, 242

NEWS 108

BRICK 248



BRASS 95



BRASS 45



MORE 10



BRICK 242, 241



MOON 39

NEXT 999



MIK 10

BRICK 307

BRICK 244, 241, 242

BRICK 248



MORE 24



NEWS 108



BRASS 45





BRASS 96



MOON 33



GRAY 23



GHOST 23





UP 28



GRAY 23

MOON 33

Charming loft



BRASS 95



BRICK 36

BRICK M

UP 23



MOON 39

BRASS 44

NEXT 22 P

GRAY 49

GRAY 42

BRICK 85

MORE 25 P



MOON 39



BRICK 98



BRICK 98

BRICK 85

MORE 25 P

GRAY 42



BRICK 85



BRICK 66

BRICK 66



MORE 07 L, 07 R

BRICK 19

NEXT 998

CROSS 45



BRICK 23

MOON 36



CROCO 95

BRICK 19

MOON 36

BRICK 23

MORE

MODULAR SYSTEM, SOFAS AND ARMCHAIRS: MAXIMUM FLEXIBILITY AND SIMPLICITY.

Modular elements in different shapes and sizes,
upholstered with polyurethane foams, removable covers.

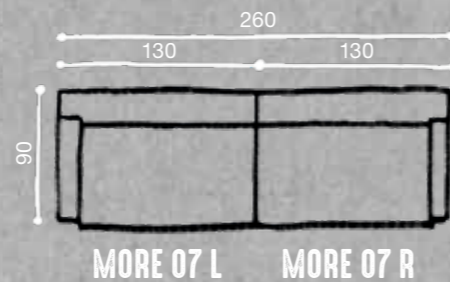

p. 110

Some different configurations

Esempi di configurazione / Garniturbeispiele / Exemples de composition

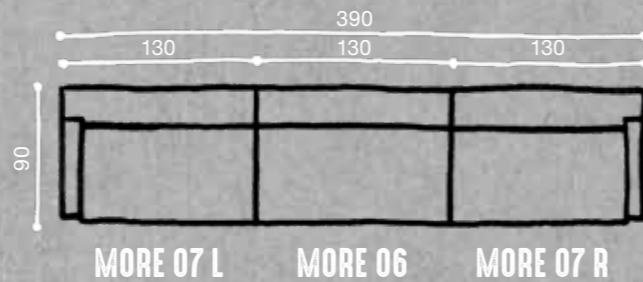
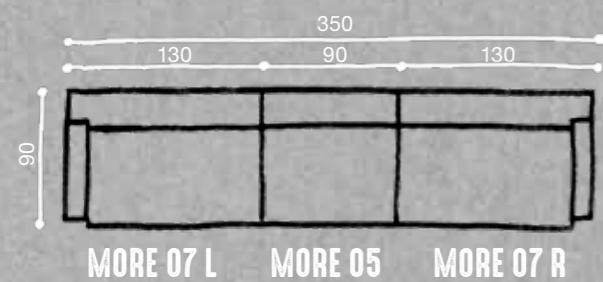

Elementi componibili in varie forme e misure, imbottitura in poliuretano espanso, rivestimenti sfoderabili.

Anbau-Elemente in unterschiedlichen Größen und Formen, Polsterung aus Polyurethanschaum, abziehbar.

Eléments pour composition dans plusieurs formes et dimensions, rembourrage en mousse polyuréthane, déhoussables.

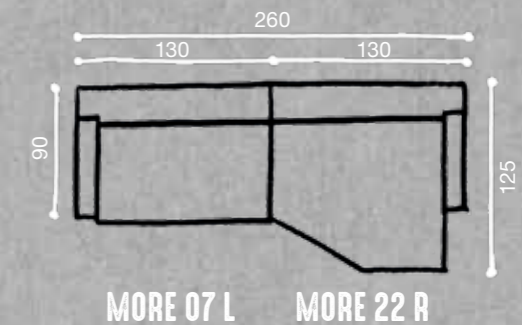

p. 19

Some different configurations

Esempi di configurazione / Garniturbeispiele / Exemples de composition

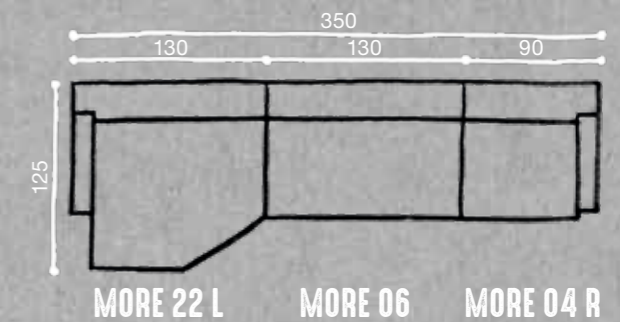
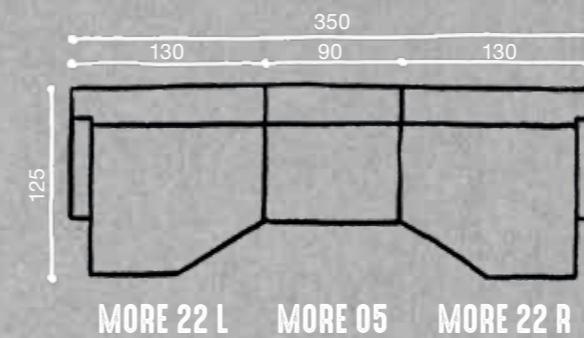

MORE

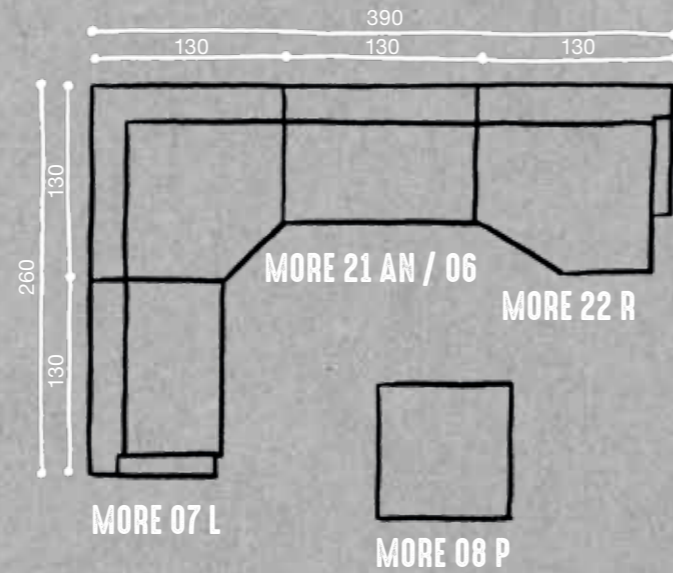

p. 11

Some different configurations

Esempi di configurazione / Garniturbeispiele / Exemples de composition

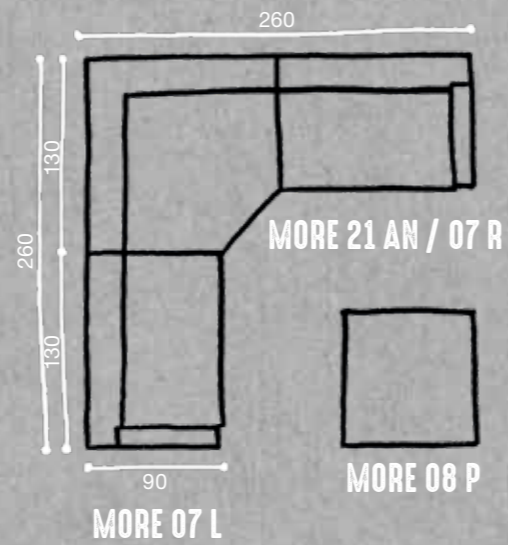
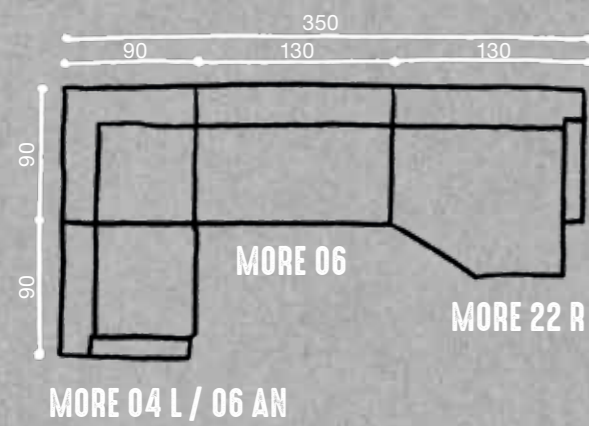

p. 70

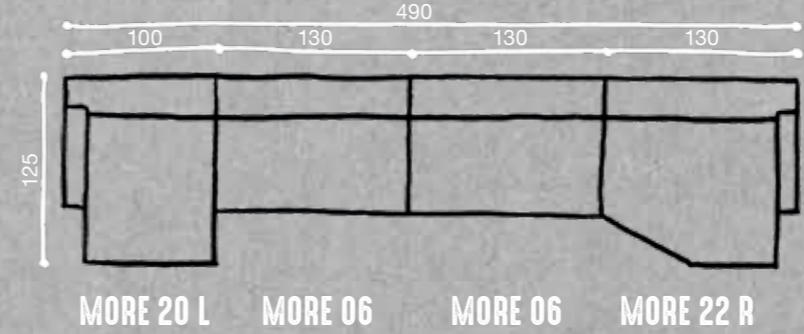

Some different configurations

Esempi di configurazione / Garniturbeispiele / Exemples de composition

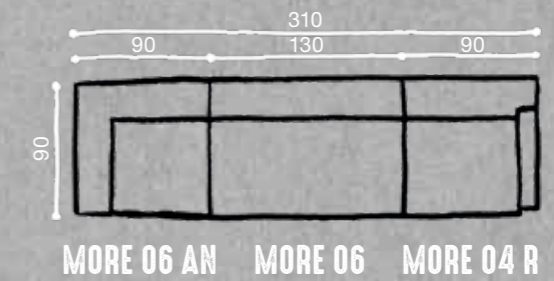
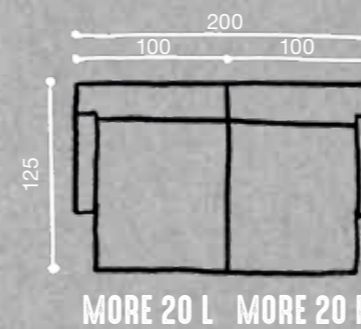
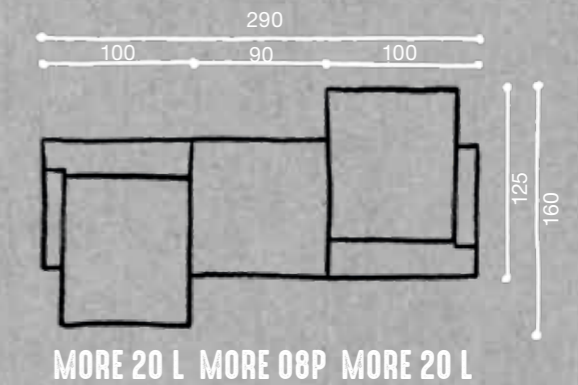
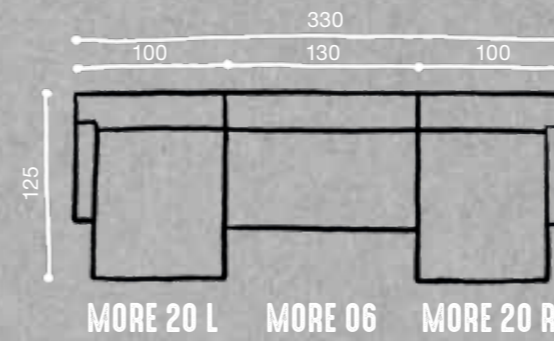

MIK

SOFA FOR CONTEMPORARY LIVING,
AVAILABLE IN TWO SIZES.

Sofa, upholstered with polyurethane foams.
Removable covers characterized by a blanket-stitching.



BLANKET-STITCHING



1000 WHITE



4525 SPRITZ



6125 AVIO



6375 PERLA

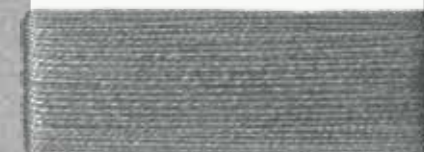

6450 ARDESIA



6525 GRAFITE

Divano, imbottitura in poliuretano espanso,
rivestimenti sfoderabili rifiniti con cucitura
punto cavallo.

Sofa, Polsterung aus Polyurethanschaum,
abnehmbare Hussen mit Langettenstich verziert.

Canapé déhoussable, rembourrage en mousse
polyuréthane, housses avec bordure au point
de feston.

BRICK 133 / 134

Rectangular table, cast polished aluminium legs, wooden beam.
Fixed veneered slat top in walnut/oak or in white Carrara marble.
Available wood finishes: natural lacquered American walnut;
bleached oak; white, grey, air force blue, black lacquered oak.

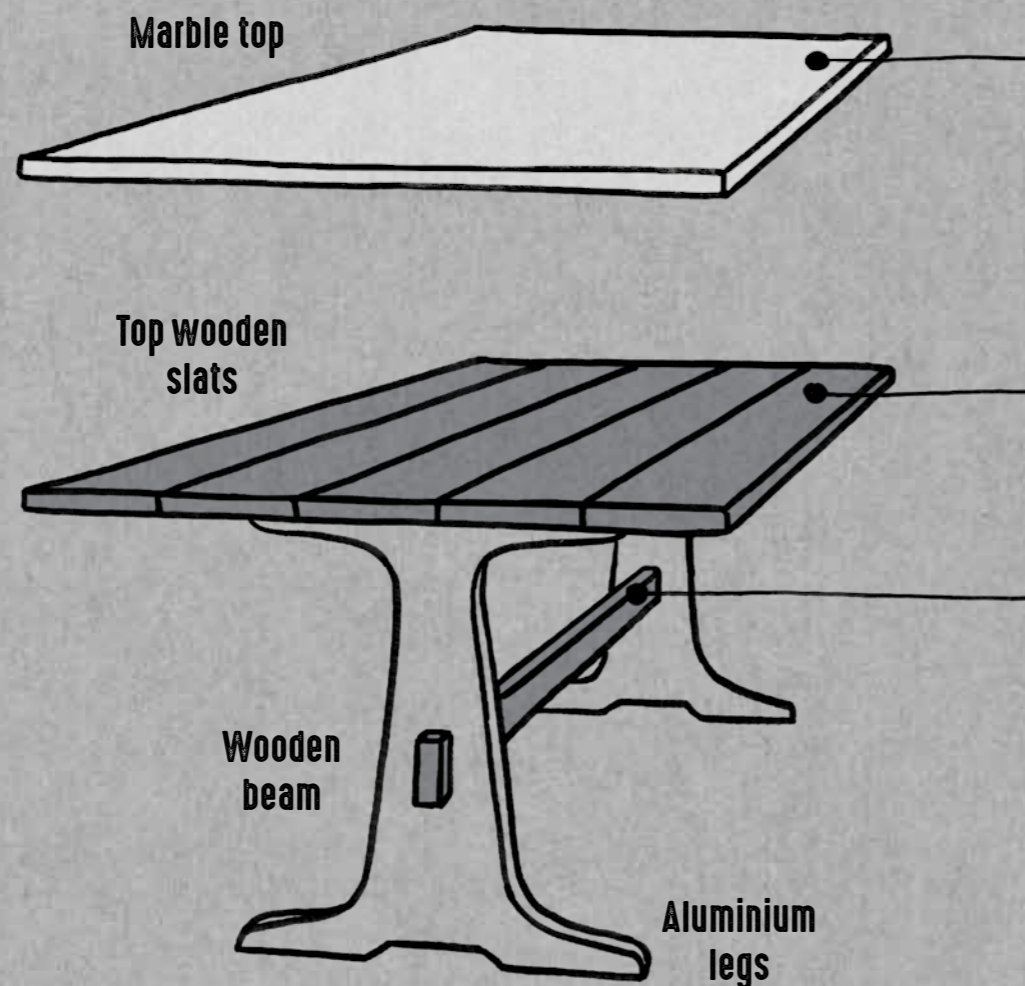

BRICK 133
240 x 100 x H73 cm

BRICK 134
180 x 100 x H73 cm



Tavolo rettangolare, gambe in fusione di alluminio lucidato con traverso in legno.
Piano fisso a doghe impiallacciate di noce/rovere o in marmo bianco Carrara.
Finiture legno disponibili: noce Canaletto naturale; rovere sbiancato o rovere laccato bianco, grigio, avio, nero.

Rechteckiger Tisch, FüÙe aus Gussaluminium, poliert, Verstrebung aus Holz.
Feste Leistenplatte aus Nussbaum / Eiche oder aus weiÙem Carrara-Marmor.
Lieferbare Farbausföhrungen: Nussbaum natur lasiert; Eiche gebleicht; Eiche weiÙ, grau, schieferblau, schwarz lackiert.

Table rectangulaire, pieds en fonte d'aluminium poli, traverse en bois.
Plateau fixe à lattes de noyer /chêne plaqué ou en marbre blanc de Carrare.
Finitions du bois disponibles : noyer américain verni naturel; chêne blanchi; chêne laqué blanc, gris, bleu ardoise, noir.

BRICK

231 / 232 / 233 / 234

Square and rectangular tables in different sizes, feet/frame in walnut.
 Plain fixed veneer top in walnut or in white Carrara marble.
 Available wood finishes: natural, white, grey, air force blue
 or black lacquered American walnut.

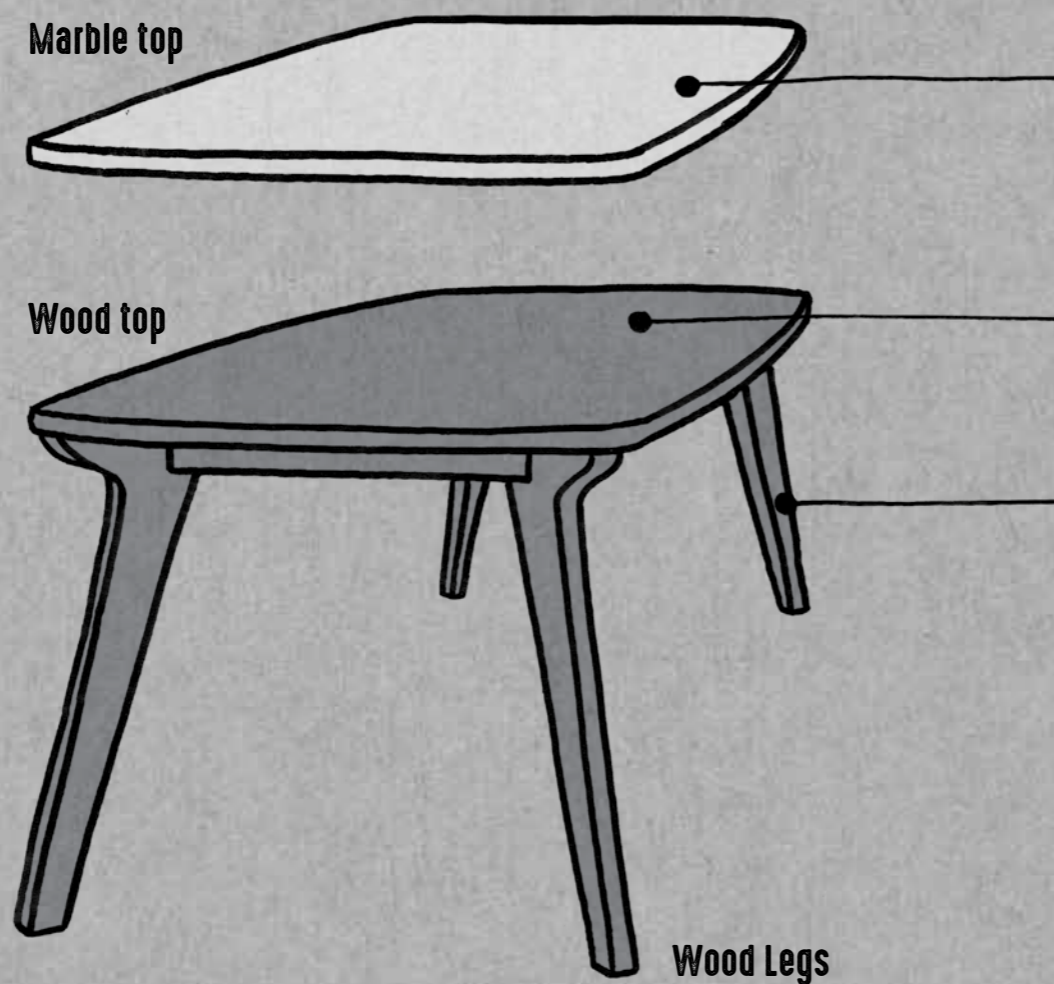

BRICK 231

138 x 138 x H73 cm



BRICK 232

100 x 100 x H73 cm

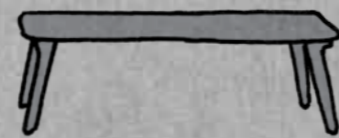

BRICK 233

240 x 100 x H73 cm

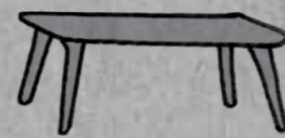

BRICK 234

180 x 100 x H73 cm



Tavoli quadrati e rettangolari in diverse misure, gambe e struttura in noce.
 Piano fisso liscio in noce impiallacciato o in marmo bianco Carrara.
 Finiture legno disponibili: noce Canaletto verniciato naturale o laccato bianco, grigio, avio o nero.

Viereckige und rechteckige Tische in unterschiedlichen Massen, Füße und Rahmen aus Nussbaum.
 Feste durchgehende Platte furniert aus Nussbaum oder weißem Carrara-Marmor.
 Lieferbare Farbausführungen: Nussbaum natur lasiert, weiß, grau, schieferblau oder schwarz lackiert.

Tables carrées ou rectangulaires dans plusieurs dimensions, pieds et structure en noyer.
 Plateau fixe lisse plaqué en noyer ou bien en marbre blanc de Carrare.
 Finitions du bois disponibles : noyer américain vernis naturel ou bien laqué blanc, gris, bleu ardoise, noir.

MOON

33 / 34 / 36

Collection of tables in different sizes and shapes,
available with cast aluminium or white Carrara marble top.
Base in blue ceramic.

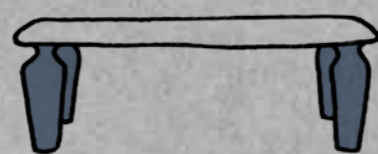
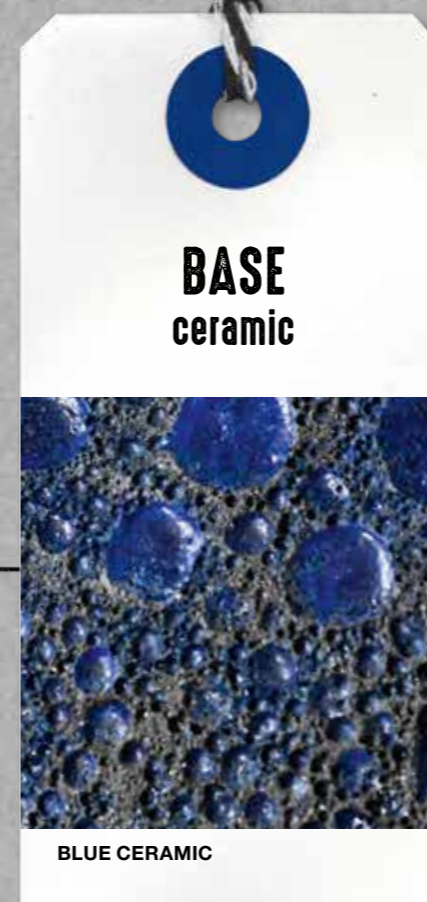
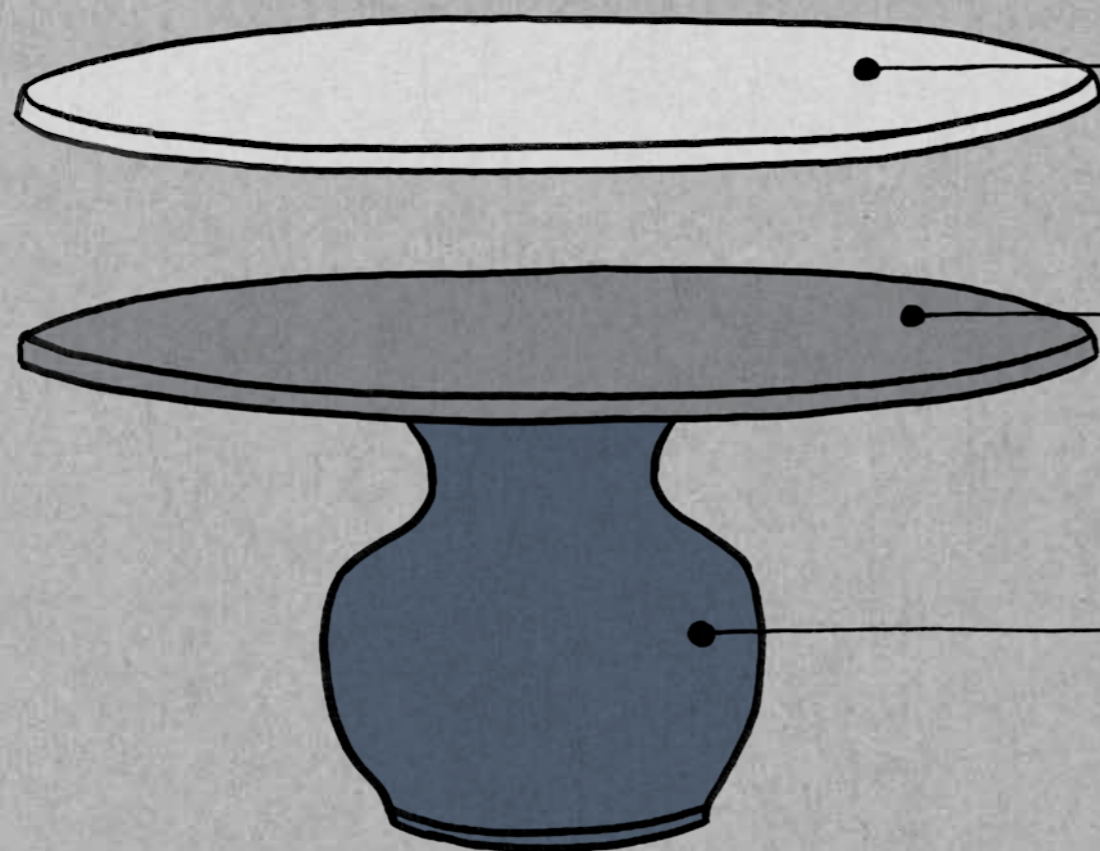

MOON 33

250 x 130 x H74 cm



MOON 36

Ø160 x H74 cm



MOON 34

Ø130 x H74 cm

Collezione di tavoli di diverse forme e misure, con piano in fusione di alluminio o in marmo bianco di Carrara. Base in ceramica blu.

Tischkollektion mit unterschiedlichen Massen und Formen. Platte aus Gussaluminium oder aus weißem Carrara-Marmor. Unterbau aus blauer Keramik.

Collection de tables dans plusieurs dimensions et formes, dessus en fonte d'aluminium ou en marbre blanc de Carrara. Piétement en céramique bleu.

NEXT 232 / 236

Round table, central concrete base, crackle finishing.
Top in handbrushed glossy gray or white lacquered pine
or in white Carrara marble.

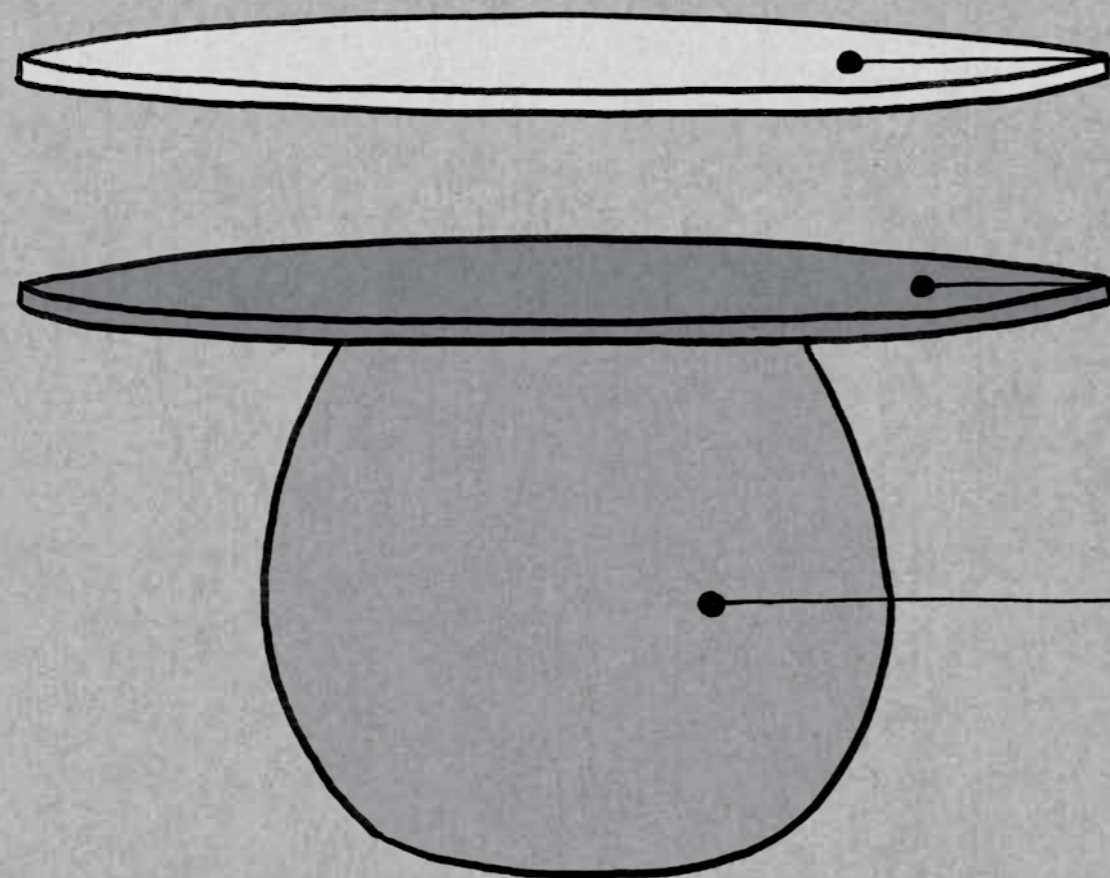

NEXT 232
Ø 140 x H73 cm

NEXT 236
Ø 160 x H73 cm



Tavolo tondo, base centrale in cemento finitura crackle. Piano in abete spazzolato a mano laccato grigio o bianco lucido o in marmo bianco Carrara.

Runder Tisch, Unterbau aus Beton in Craquelé-Optik. Platte aus handgebürsteter Pinie, glänzend grau oder weiß lackiert oder aus weißem Carrara-Marmor.

Table ronde, piétement en béton, effet craquelé, plateau en sapin brossé à la main, laqué gris ou blanc brillant ou en marbre blanc de Carrare.



PAG. 4-5

- 1 MIK 12 / NATURAL Lino bianco - B



PAG. 6-7

- 1 UP 28 / ATMOSFERA Tempesta - C
- 2 UP 28 / ARTIST Van Gogh - C
- 3 UP 28 / GLAMOUR Jeans Nero - D



PAG. 8-9

- 1 MORE 07 L - 21 AN - 06 - 22 R / BIRDS Crow - C

- CUSHIONS:**
- 2 TRAMA Vaniglia - C
 - 3 BIRDS Crow - C
 - 4 ATMOSFERA Tempesta - C
 - 5 STONE WASHED Panna - D



PAG. 34-35

- 1 BRICK 228 / ANIMALS Pigeon - C



PAG. 38-39

- 1 BRICK 65 / JACK Marrone - C
- 2 UP 80 E / LUME Luce - B

- BED RUNNER:**
- 3 UP 80 E / MAPS Street - C
 - 4 NEXT 999 - Slate



PAG. 42-43

- 1 BRICK 312 / BIRDS Robin - C



PAG. 14-15

- 1 BRICK 215 / NOA Pinot - B
- 2 BRICK 221 / ARTIST Mirò - C
- 3 BRICK 221 / GLAMOUR Jeans Nero - D



PAG. 16-17

- 1 NEXT 998 / Blue
- 2 UP 80 E / ANIMALS Rhino - C



PAG. 20-21

- 1 BRICK 312 / IUTA Grigio - D
- 2 NEXT 998 - Silver
- 3 NEXT 999 - Slate
- 4 NEXT 999 - Brown
- 5 MORE 07 L - 22 R / ARTIST Renoir - C

- CUSHIONS:**
- 6 TRAMA Ginepro - C
 - 7 NOA Onix - C



PAG. 44-45

- 1 MIK 10 / WINDS Ostro - C



PAG. 46-47

- 1 BRICK 309 / ATMOSFERA Bufera - C
- 2 MORE 24 P / ANIMALS Butterfly - C



PAG. 52-53

- 1 BRICK 221 / ANIMALS Butterfly - C
- 2 BRICK 221 / IUTA Grigio - D
- 3 BRICK 221 / ANIMALS Snake - C



PAG. 24-25

- 1 BRICK 67 / LUME Ombra - B
- 2 MORE 12 / ANIMAL Rhino - C

- CUSHIONS:**
- 3 TRAMA Ginepro - C
 - 4 BIRDS Eagle - C



PAG. 28-29

- 1 BRICK 305 / NOA Onix - B

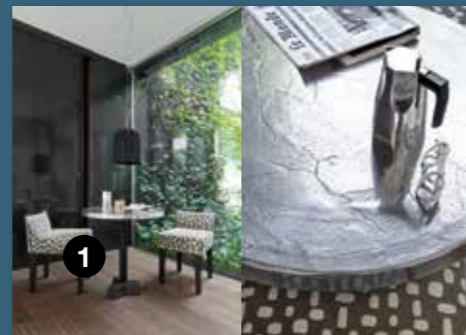

PAG. 30-31

- 1 UP 23 / ATMOSFERA Brezza - C



PAG. 54-55

- 1 BRICK 215 / WINDS Scirocco - C



PAG. 56-57

- 1 BRICK 80 E / DEUS Bacco - C
- 2 BRICK 307 / MAPS Alley - C

- CUSHIONS:**
- 3 WINDS Scirocco - C
 - 4 DEUS Bacco - C

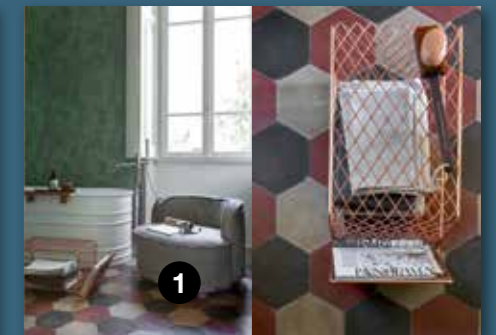

PAG. 58-59

- 1 MORE 25 / BIRDS Eagle - C



PAG. 60-61

- 1 NUVOLA 05 / NATURAL Lino bianco - B
- 2 MORE 08 / DEUS Pegaso - C



PAG. 62-63

- 1 MIK 12 / ARTIST Monet - C



PAG. 68-69

- 1 UP 23 / GLAMOUR Jeans Grigio - D



PAG. 90-91

- 1 NEXT 999 Blue
- 2 MORE 10 / DEUS Poseidone - C

- CUSHIONS:**
3 MAPS Highway - C



PAG. 92-93

- 1 MIK 10 / TRAMA Aneto - C
- 2 BRICK 307 / ATMOSFERA Uragano - C



PAG. 94-95

- 1 MORE 24 / MAPS Highway - C



PAG. 70-71

- 1 NEXT 999 - Silver
- 2 NEXT 999 - Slate
- 3 MORE 20 L - 06 - 22 R / BIRDS Dove - C

- CUSHIONS:**
4 LUME Ombra - B
5 BIRDS Heron - C
6 STRUCTURES White - C
7 DEUS Pegaso - C



PAG. 74-75

- 1 GHOST 23 / NATURAL Lino bianco - B



PAG. 78-79

- 1 BRICK 80 E / WINDS Bora - C

- BED RUNNER:**
2 BIRDS Heron - C

- CUSHIONS:**
3 ANIMAL Pigeon - C



PAG. 98-99

- 1 UP 28 / MAPS Highway - C
- 2 GHOST 23 / KANTHA Primavera - C
- 3 GRAY 23 / POLY Mare - B



PAG. 100-101

- 1 UP 23 / NOA Ducke - B



PAG. 102-103

- 1 NEXT 22 P / DEUS Athena - C

- CUSHIONS:**
2 STRUCTURE Topazio - C
3 MORE 25 P / ANIMAL Snake - B
4 BRICK 85 / JACK Verde - C



PAG. 84-85

- 1 NEXT 18 / BIRDS Eagle - C
- 2 NEXT 999 - Blue

- CUSHIONS:**
3 BIRDS Peacock - C



PAG. 86-87

- 1 NUVOLA 05 / 3D Blu - E



PAG. 88-89

- 1 BRICK 18 / NOA Bluepoppy - B
- 2 MORE 07 L - 06 - 22 R / ANIMAL Elephant - C

- CUSHIONS:**
3 Munch - C
4 BIRDS Crow - C



PAG. 108-109

- 1 BRICK 85 / JACK Verde - C
- 2 BRICK 66 / JACK Verde - C



PAG. 110-111

- 1 NEXT 998 Brown
- 2 BRICK 19 / GUNNAR Lapislazzulo - C
- 3 MORE 07 L - 07 R / MALTA Granito - C

- CUSHIONS:**
4 ANIMAL Snake - C



PAG. 112-113

- 1 BRICK 19 / GUNNAR Lapislazzulo - C
- 2 BRICK 19 / ARTIST Mirò - C

BRASS 43 / 44

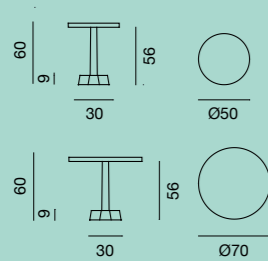

p. 30 / 86

Tavolino, base in fusione di ghisa. Colonna in faggio tinto ebano. Piano disponibile in fusione di alluminio o in ottone lucido.

Coffee/Side table, cast iron central base. Column in ebony stained beechwood. Top in aluminium casting or in glossy brass. Couch- Beistelltisch, Unterbau aus Gusseisen.

Säule aus Buche, Farbe Ebenholz. Platte aus Gussaluminium oder aus glänzendem Messing. Guéridon, base en fonte. Colonne en hêtre teinté ébène. Dessus en fonte d'aluminium ou bien en laiton brillant.

BRASS 45 / 46

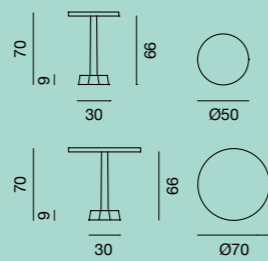

p. 87 / 88 / 90 / 95

Tavolo, base in fusione di ghisa. Colonna in faggio tinto ebano. Piano disponibile in fusione di alluminio o in ottone lucido.

Table, cast iron central base. Column in ebony stained beechwood. Top in aluminium casting or in glossy brass.

Tisch, Unterbau aus Gusseisen. Säule aus Buche, Farbe Ebenholz. Platte aus Gussaluminium oder aus glänzendem Messing.

Table, base en fonte. Colonne en hêtre teinté ébène. Dessus en fonte d'aluminium ou bien en laiton brillant.

BRASS 47

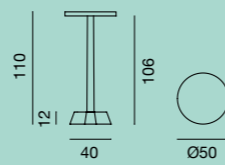

p. 6-7

Tavolo, base in fusione di ghisa. Colonna in faggio tinto ebano. Piano disponibile in fusione di alluminio o in ottone lucido.

Table, cast iron central base. Column in ebony stained beechwood. Top in aluminium casting or in glossy brass.

Tisch, Unterbau aus Gusseisen. Säule aus Buche, Farbe Ebenholz. Platte aus Gussaluminium oder aus glänzendem Messing.

Table, base en fonte. Colonne en hêtre teinté ébène. Dessus en fonte d'aluminium ou bien en laiton brillant.

BRICK 23

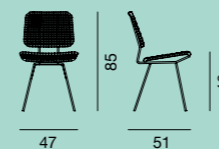

p. 12-13 / 111 / 113

Sedia con struttura in acciaio cromato, seduta e schienale intrecciati in pergamena grigia.

Chair, chromed steel frame, seat and back hand woven with grey rawhide.

Stuhl, Gestell aus glänzend verchromten Stahl, Sitz und Rücken mit grauem Rohleder umflochten.

Chaise, structure en acier chromé brillant, assise et dossier en parchemin tressé teinté gris.

BRICK 32

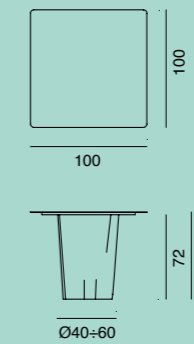

Tavolo, base realizzata con sezione di tronco di carpino naturale, scortecciato, piano quadrato 100x100 cm in lamiera di ferro cerata.

Table, base made of natural barked hornbeam trunk section, top in waxed iron plate, 100x100 cm.

Tisch, Unterbau aus Weißbuche, naturbelassen, abgerindet, viereckige Platte aus gewachstem Stahl, 100x100 cm.

Table, piétement en bois naturel de charme, écorcé, plateau carré en tôle de fer cirée 100x100 cm.

BRICK 33

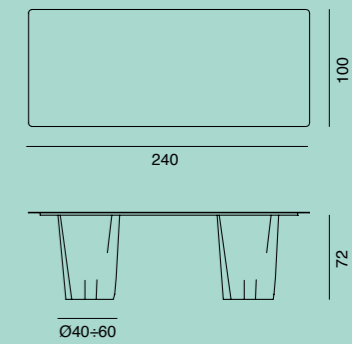

p. 74-75

Tavolo, base realizzata con sezione di tronco di carpino naturale, scortecciato, piano rettangolare 240x100 cm in lamiera di ferro cerata.

Table, base made of natural barked hornbeam trunk sections, top in waxed iron plate, 240x100 cm.

Tisch, Unterbau aus Weißbuche, naturbelassen, abgerindet, rechteckige Platte aus gewachstem Stahl, 240x100 cm.

Table, pieds en bois naturel de charme, écorcé, plateau rectangulaire en tôle de fer cirée 240x100 cm.

BRICK XS / S / M / L

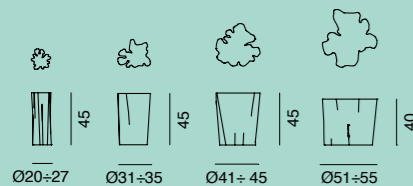

p. 60 / 62 / 65 / 68 / 80 / 100 / 101

Sezione di tronco di carpino naturale scortecciato.

Natural barked hornbeam trunk section.

Baumstamm-Abschnitt aus Weißbuche, naturbelassen, abgerindet.

Rondin en bois naturel de charme, écorcé.

BRICK 18

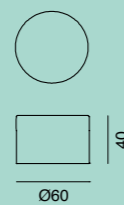

p. 88

Pouf, imbottitura in poliuretano espanso. Rivestimento sfoderabile.

Ottoman, upholstery with polyurethane foams, removable cover.

Hocker, Polsterung aus Polyurethanschaum, abziehbar.

Pouf, rembourrage en mousse polyuréthane, déhoussable.

BRICK 19

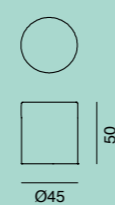

p. 113

Pouf, imbottitura in poliuretano espanso. Rivestimento sfoderabile.

Ottoman, upholstery with polyurethane foams, removable cover.

Hocker, Polsterung aus Polyurethanschaum, abziehbar.

Pouf, rembourrage en mousse polyuréthane, déhoussable.

BRICK 34

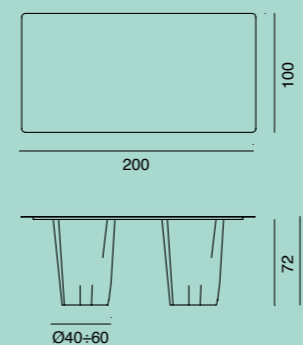

Tavolo, base realizzata con sezione di tronco di carpino naturale, scortecciato, piano rettangolare 200x100 cm in lamiera di ferro cerata.

Table, base made of natural barked hornbeam trunk sections, top in waxed iron plate, 200x100 cm.

Tisch, Unterbau aus Weißbuche, naturbelassen, abgerindet, rechteckige Platte aus gewachstem Stahl, 200 x 100 cm.

Table, pieds en bois naturel de charme, écorcé, plateau rectangulaire en tôle de fer cirée 200x100 cm.

BRICK 36

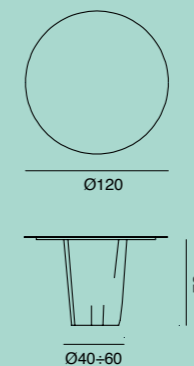

p. 101

Tavolo, base realizzata con sezione di tronco di carpino naturale, scortecciato, piano rotondo Ø 120 cm in lamiera di ferro cerata.

Table, base made of natural barked hornbeam trunk section, round top in waxed iron plate, Ø 120 cm.

Tisch, Unterbau aus Weißbuche, naturbelassen, abgerindet, Platte aus gewachstem Stahl, Ø 120 cm.

Table, piétement en bois naturel de charme, écorcé, plateau rond en tôle de fer cirée Ø 120 cm.

BRICK 51

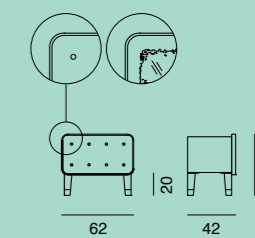

p. 39 / 81

Comodino in noce, un cassetto, piedi in noce con terminale verniciato grigio alluminio. Frontale cassetto disponibile a specchio serigrafato o tessile (tutti i tessuti di campionario eccetto 3D e Lino bianco). Finiture struttura: noce canaletto verniciato naturale, laccato opaco bianco, grigio, avio, nero.

Night table in walnut, one drawer, walnut feet with finals painted in aluminium grey. Drawer's front with silkscreen mirror or covered in fabric (all our fabrics except for 3D and Lino bianco). Frame finishes: natural, mat white, grey, air force blue, black lacquered American walnut.

Nachttisch aus Nussbaum, eine Schublade, Füße aus Nussbaum mit alugrau lackiertem Abschluss. Schubladenfront mit Spiegel mit Siebdruck oder stoffbespannt, lieferbar mit allen unseren Stoffen mit Ausnahme von 3D und Lino bianco. Korpusausführungen: amerikanisches Nussbaum natur lasiert, Nussbaum matt weiß, grau, schieferblau, schwarz lackiert.

Chevet en noyer, un tiroir, pieds en noyer avec extrémité laquée gris aluminium. Face tiroir avec miroir sérigraphié ou bien revêtue dans tous nos tissus sauf 3D et Lino bianco. Finitions structure: noyer américain verni naturel, noyer laqué blanc mat, gris, bleu ardoise, noir.

BRICK 221 / 223

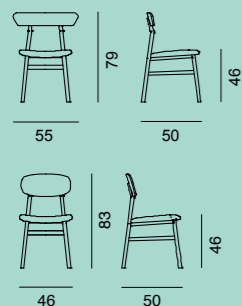

p. 15 / 51 / 52-53

Sedia, struttura in noce o faggio. Finiture legno disponibili: noce Canaletto verniciato naturale o faggio laccato bianco, grigio, avio o nero. Sedile e schienale imbottiti, rivestimento fisso.

Side chair, frame in walnut or beech. Available wood finishes: natural lacquered American walnut; white, grey, air force blue or black lacquered beech. Upholstered seat and back, not removable cover.

Stuhl, Gestell aus Nussbaum oder Buche.

Lieferbare Farbausführungen: Nussbaum natur lasiert, Buche weiß, grau, schieferblau oder schwarz lackiert. Gepolsterte Sitz und Rücken, nicht abziehbar.

Chaise, structure en hêtre ou bien en noyer. Finitions du bois disponibles: noyer américain vernis naturel; hêtre laqué blanc, gris, bleu ardoise, noir. Assise et dossier rembourrés, non déhoussables.

BRICK 228

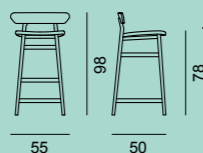

p. 34

Sgabello, struttura in noce o faggio. Finiture legno disponibili: noce Canaletto verniciato naturale o faggio laccato bianco, grigio, avio o nero. Sedile e schienale imbottiti, rivestimento fisso.

Barstool, frame in walnut or oak. Available wood finishes: natural lacquered American walnut; white, grey, air force blue or black lacquered oak. Upholstered seat and back, not removable cover.

Barhocker, Gestell aus Nussbaum oder Buche.

Lieferbare Farbausführungen: Nussbaum natur lasiert, Buche weiß, grau, schieferblau oder schwarz lackiert. Gepolsterte Sitz und Rücken, nicht abziehbar.

Tabouret, structure en hêtre ou bien en noyer. Finitions du bois disponibles: noyer américain vernis naturel; hêtre laqué blanc, gris, bleu ardoise, noir. Assise et dossier rembourrés, non déhoussables.

BRICK 231

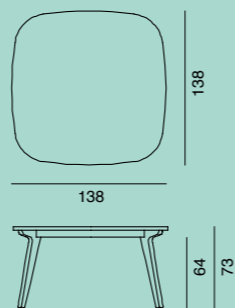

p. 32-33

Tavolo quadrato, gambe e struttura in noce. Piano fisso liscio in noce impiallacciato o in marmo bianco Carrara. Finiture legno disponibili: noce Canaletto verniciato naturale o laccato bianco, grigio, avio o nero.

Square table, feet/frame in walnut. Plain fixed veneer top in walnut or in white Carrara marble. Available wood finishes: natural, white, grey, air force blue or black lacquered American walnut.

Viereckiger Beistelltisch aus Nussbaum oder Eiche massiv. Platte aus Nussbaum/Eiche, oder aus weißem Carrara-Marmor. Lieferbare Farbausführungen: Nussbaum natur lasiert, weiß, grau, schieferblau oder schwarz lackiert.

Table carrée, pieds et structure en noyer. Plateau fixe lisse plaqué en noyer ou bien en marbre blanc de Carrare. Finitions du bois disponibles: noyer américain vernis naturel ou bien laqué blanc, gris, bleu ardoise, noir.

BRICK 241



p. 11 / 16 / 46 / 48-49 / 60 / 71 / 84 / 90 / 93

Tavolino basso triangolare in massello di noce o rovere. Piano in noce/rovere o in marmo bianco Carrara. Finiture legno disponibili: noce Canaletto naturale; rovere sbiancato o laccato bianco, grigio, avio o nero.

Triangle-shaped side table in solid walnut or oak. Top in walnut/oak or in white Carrara marble. Available wood finishes: natural lacquered American walnut; bleached oak; white, grey, air force blue or black lacquered oak.

Dreieckiger Beistelltisch aus Nussbaum oder Eiche massiv. Platte aus Nussbaum/Eiche, oder aus weißem Carrara-Marmor. Lieferbare Farbausführungen: Nussbaum natur lasiert; Eiche gebleicht, weiß, grau, schieferblau oder schwarz lackiert.

Guéridon triangulaire en noyer ou en chêne massif. Dessus en noyer/chêne ou en marbre blanc de Carrare. Finitions du bois disponibles: noyer américain vernis naturel; chêne blanchi ou laqué blanc, gris, ardoise, noir.

BRICK 242

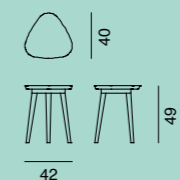

p. 8 / 11 / 28-29 / 48-49 / 85 / 90 / 93

Tavolino triangolare in massello di noce o rovere. Piano in noce/rovere o in marmo bianco Carrara. Finiture legno disponibili: noce Canaletto naturale; rovere sbiancato o laccato bianco, grigio, avio o nero.

Triangle-shaped side table in solid walnut or oak. Top in walnut/oak or in white Carrara marble. Available wood finishes: natural lacquered American walnut; bleached oak; white, grey, air force blue or black lacquered oak.

Dreieckiger Beistelltisch aus Nussbaum oder Eiche massiv. Platte aus Nussbaum/Eiche, oder aus weißem Carrara-Marmor. Lieferbare Farbausführungen: Nussbaum natur lasiert; Eiche gebleicht, weiß, grau, schieferblau oder schwarz lackiert.

Guéridon triangulaire en noyer ou en chêne massif. Dessus en noyer/chêne ou en marbre blanc de Carrare. Finitions du bois disponibles: noyer américain vernis naturel; chêne blanchi ou laqué blanc, gris, ardoise, noir.

BRICK 244

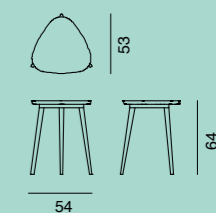

p. 10 / 11 / 49 / 89 / 93

Tavolino alto triangolare in massello di noce o rovere. Piano in noce/rovere o in marmo bianco Carrara. Finiture legno disponibili: noce Canaletto naturale; rovere sbiancato o laccato bianco, grigio, avio o nero.

Triangle-shaped tea table in solid walnut or oak. Top in walnut/oak or in white Carrara marble. Available wood finishes: natural lacquered American walnut; bleached oak; white, grey, air force blue or black lacquered oak.

Dreieckiger Teetisch aus Nussbaum oder Eiche massiv. Platte aus Nussbaum/Eiche, oder aus weißem Carrara-Marmor. Lieferbare Farbausführungen: Nussbaum natur lasiert; Eiche gebleicht, weiß, grau, schieferblau oder schwarz lackiert.

Table de thé triangulaire en noyer ou en chêne massif. Dessus en noyer/chêne ou en marbre blanc de Carrare. Finitions du bois disponibles: noyer américain vernis naturel; chêne blanchi ou laqué blanc, gris, ardoise, noir.

BRICK 232

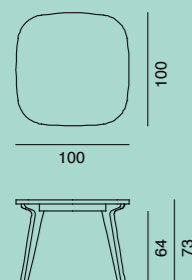

p. 15 / 36-37

Tavolo quadrato, gambe e struttura in noce. Piano fisso liscio in noce impiallacciato o in marmo bianco Carrara. Finiture legno disponibili: noce Canaletto verniciato naturale o laccato bianco, grigio, avio o nero.

Square table, feet/frame in walnut. Plain fixed veneer top in walnut or in white Carrara marble. Available wood finishes: natural, white, grey, air force blue or black lacquered American walnut.

Viereckiger Tisch, Füße und Rahmen aus Nussbaum. Feste durchgehende Platte furniert aus Nussbaum oder weißem Carrara-Marmor. Lieferbare Farbausführungen: Nussbaum natur lasiert, weiß, grau, schieferblau oder schwarz lackiert.

Table carrée, pieds et structure en noyer. Plateau fixe lisse plaqué en noyer ou bien en marbre blanc de Carrare. Finitions du bois disponibles: noyer américain vernis naturel ou bien laqué blanc, gris, bleu ardoise, noir.

BRICK 233

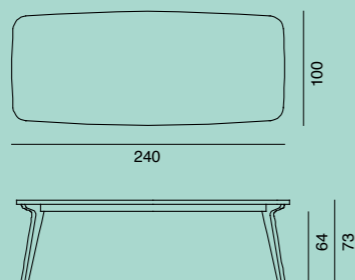

p. 15 / 36-37

Tavolo rettangolare, gambe e struttura in noce. Piano fisso liscio in noce impiallacciato o in marmo bianco Carrara. Finiture legno disponibili: noce Canaletto verniciato naturale o laccato bianco, grigio, avio o nero.

Rectangular table, feet/frame in walnut. Plain fixed veneer top in walnut or in white Carrara marble. Available wood finishes: natural, white, grey, air force blue or black lacquered American walnut.

Rechteckiger Tisch, Füße und Rahmen aus Nussbaum. Feste durchgehende Platte furniert aus Nussbaum oder weißem Carrara-Marmor. Lieferbare Farbausführungen: Nussbaum natur lasiert, weiß, grau, schieferblau oder schwarz lackiert.

Table rectangulaire, pieds et structure en noyer. Plateau fixe lisse plaqué en noyer ou bien en marbre blanc de Carrare. Finitions du bois disponibles: noyer américain vernis naturel ou bien laqué blanc, gris, bleu ardoise, noir.

BRICK 234

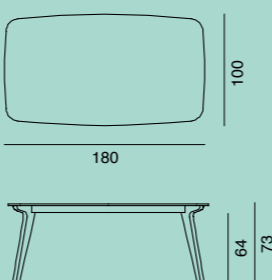

p. 4 / 18-19 / 20-21 / 62-63 / 64 / 70-71 / 82 / 84

Tavolino ovale, struttura in noce o rovere. Piano in noce/rovere massiccio o impiallacciato (247 R), in marmo bianco Carrara. Finiture legno disponibili: noce Canaletto naturale; rovere sbiancato o laccato bianco, grigio, avio o nero.

Oval coffee table, frame in walnut or oak. Top in walnut/oak, solid or veneer, in white Carrara marble. Available wood finishes: natural lacquered American walnut; bleached oak; white, grey, air force blue or black lacquered oak.

Ovaler Couchtisch, Gestell aus Nussbaum oder Eiche. Platte aus Nussbaum/Eiche, massiv oder furniert, aus weißem Carrara-Marmor. Lieferbare Farbausführungen: Nussbaum natur lasiert; Eiche gebleicht, weiß, grau, schieferblau oder schwarz lackiert.

Table basse ovale, structure en noyer ou en chêne. Dessus en noyer ou en chêne, massif ou plaqué, en marbre blanc de Carrare. Finitions du bois disponibles: noyer américain vernis naturel; chêne blanchi ou laqué blanc, gris, bleu ardoise, noir.

BRICK 247 / 247 R

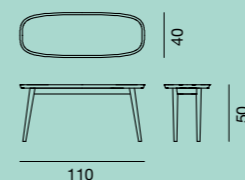

p. 11 / 19 / 20-21 / 62-63 / 64 / 70-71 / 89 / 92

Tavolino ovale, struttura in noce o rovere. Piano in noce/rovere massiccio o impiallacciato (248 R), in marmo bianco Carrara. Finiture legno disponibili: noce Canaletto naturale; rovere sbiancato o laccato bianco, grigio, avio o nero.

Oval coffee table, frame in walnut or oak. Top in walnut/oak, solid or veneer, in white Carrara marble. Available wood finishes: natural lacquered American walnut; bleached oak; white, grey, air force blue or black lacquered oak.

Ovaler Couchtisch, Gestell aus Nussbaum oder Eiche. Platte aus Nussbaum/Eiche, massiv oder furniert, aus weißem Carrara-Marmor. Lieferbare Farbausführungen: Nussbaum natur lasiert; Eiche gebleicht, weiß, grau, schieferblau oder schwarz lackiert.

Table basse ovale, structure en noyer ou en chêne. Dessus en noyer ou en chêne, massif ou plaqué, en marbre blanc de Carrare. Finitions du bois disponibles: noyer américain vernis naturel; chêne blanchi ou laqué blanc, gris, bleu ardoise, noir.

BRICK 248 / 248 R

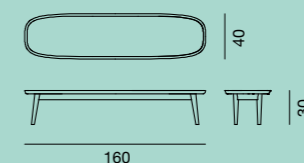

p. 28-29

Poltrona, struttura in noce o rovere, seduta e schienale imbottiti in poliuretano espanso. Rivestimento sfoderabile. Finiture legno disponibili: noce Canaletto naturale, rovere sbiancato o laccato bianco, grigio, avio o nero.

Armchair, frame in American walnut or oak, upholstered seat and back in polyurethane foam, removable cover. Available wood finishes: natural lacquered American walnut; bleached oak; white, grey, air force blue or black lacquered oak.

Sessel aus amerikanischem Nussbaum oder Eiche, Sitz und Rücken aus Polyurethanschäum, abziehbar. Lieferbare Farbausführungen: Nussbaum natur lasiert; Eiche gebleicht, weiß, grau, schieferblau oder schwarz lackiert.

Fauteuil en noyer ou en chêne, assise et dossier en mousse polyuréthane, déhoussable. Finitions du bois disponibles: noyer américain vernis naturel; chêne blanchi ou laqué blanc, gris, bleu ardoise, noir.

BRICK 305

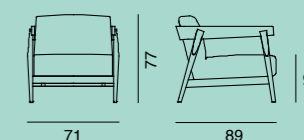

BRICK 307

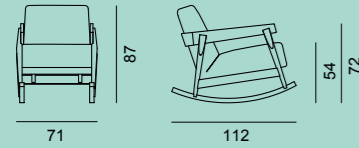

p. 57 / 93

Dondolo, struttura in noce o rovere, seduta e schienale imbottiti in poliuretano espanso. Rivestimento sfoderabile. Finiture legno disponibili: noce Canaletto naturale; rovere sbiancato o laccato bianco, grigio, avio o nero.

Rocking chair, frame in American walnut or oak, upholstered seat and back in polyurethane foam, removable cover. Available wood finishes: natural lacquered American walnut; bleached oak; white, grey, air force blue or black lacquered oak.

Schaukelstuhl aus amerikanischem Nussbaum oder Eiche, Sitz und Rücken aus Polyurethanschaum, abziehbar. Lieferbare Farbausführungen: Nussbaum natur lasiert; Eiche gebleicht, weiß, grau, schieferblau oder schwarz lackiert.

Fauteuil à bascule en noyer ou en chêne, assise et dossier en mousse polyuréthane, déhoussable. Finitions du bois disponibles: noyer américain verni naturel; chêne blanchi ou laqué blanc, gris, bleu ardoise, noir.

BRICK 309

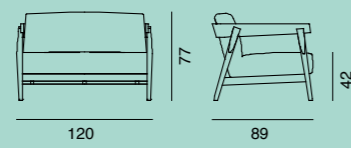

p. 46 / 48

Divano due posti, struttura in noce o rovere, seduta e schienale imbottiti in poliuretano espanso. Rivestimento sfoderabile. Finiture legno disponibili: noce Canaletto naturale; rovere sbiancato o laccato bianco, grigio, avio o nero.

Love seat, frame in American walnut or oak, upholstered seat and back in polyurethane foam, removable cover. Available wood finishes: natural lacquered American walnut; bleached oak; white, grey, air force blue or black lacquered oak.

Zweisitzer aus amerikanischem Nussbaum oder Eiche, Sitz und Rücken aus Polyurethanschaum, abziehbar. Lieferbare Farbausführungen: Nussbaum natur lasiert; Eiche gebleicht, weiß, grau, schieferblau oder schwarz lackiert.

Canapé deux places en noyer ou en chêne, assise et dossier en mousse polyuréthane, déhoussable. Finitions du bois disponibles: noyer américain verni naturel; chêne blanchi ou laqué blanc, gris, bleu ardoise, noir.

BRICK 312

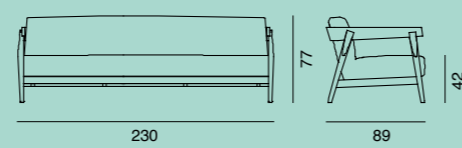

p. 20 / 42-43

Divano, struttura in noce o rovere, seduta e schienale imbottiti in poliuretano espanso. Rivestimento sfoderabile. Finiture legno disponibili: noce Canaletto naturale; rovere sbiancato o laccato bianco, grigio, avio o nero.

Sofa, frame in American walnut or oak, upholstered seat and back in polyurethane foam, removable cover. Available wood finishes: natural lacquered American walnut; bleached oak; white, grey, air force blue or black lacquered oak.

Sofa aus amerikanischem Nussbaum oder Eiche, Sitz und Rücken aus Polyurethanschaum, abziehbar. Lieferbare Farbausführungen: Nussbaum natur lasiert; Eiche gebleicht, weiß, grau, schieferblau oder schwarz lackiert.

Canapé en noyer ou en chêne, assise et dossier en mousse polyuréthane, déhoussable. Finitions du bois disponibles: noyer américain verni naturel; chêne blanchi ou laqué blanc, gris, bleu ardoise, noir.

CROSS 45

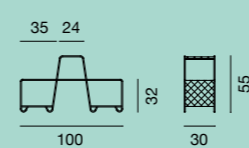

p. 110

Tavolino, struttura a rete in filo di acciaio ramato. Side table, grid frame in copper-plated steel. Beistelltisch, Netzgestell aus kupfernem Stahldraht.

Guéridon, structure à grillage en fil d'acier cuivré.

CROSS 46

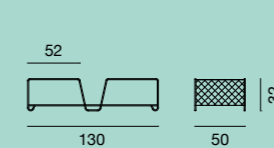

p. 42-43 / 44-45

Tavolino, struttura a rete in filo di acciaio ramato. Coffee table, grid frame in copper-plated steel. Couchtisch, Netzgestell aus kupfernem Stahldraht.

Table basse, structure à grillage en fil d'acier cuivré.

CROSS 71

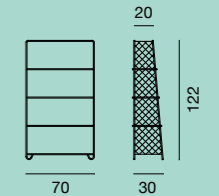

p. 54

Libreria, struttura e ripiani a rete in filo di acciaio ramato.

Bookcase, grid frame and shelves in copper-plated steel.

Regal, Netzgestell und Fachböden aus kupfernem Stahldraht.

Etagères, structure et tablettes à grillage en fil d'acier cuivré.

CARVE 07

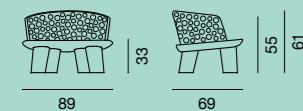

p. 9 / 11 / 17 / 22

Poltrona in mogano intagliata a mano, finitura color ebano.

Mahogany hand carved armchair, ebony finishing.

Sessel aus Mahagoni, handgeschnitzt, Farbausführung Ebenholz.

Fauteuil en acajou, taillé à la main, finition ébène.

CROSS 42

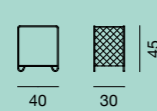

p. 40 / 43 / 45 / 56

Tavolino, struttura a rete in filo di acciaio ramato. Side table, grid frame in copper-plated steel.

Beistelltisch, Netzgestell aus kupfernem Stahldraht.

Guéridon, structure à grillage en fil d'acier cuivré.

CROSS 44

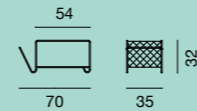

p. 58-59

Tavolino portariviste, struttura a rete in filo di acciaio ramato.

Side table / magazine rack, grid frame in copper-plated steel.

Beistelltisch / Zeitschriftständer, Netzgestell aus kupfernem Stahldraht.

Guéridon / porte-revues, structure à grillage en fil d'acier cuivré.

MIK 10

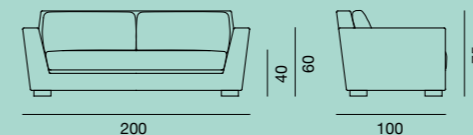

p. 44-45 / 92-93

Divano, imbottitura in poliuretano espanso, rivestimenti sfoderabili rifiniti con cucitura punto cavallo. Finiture punto cavallo disponibili: White 1000, Spritz 4525, Avio 6125, Perla 6375, Ardesia 6450, Grafite 6525, Bordeaux 8125.

Sofa, upholstered with polyurethane foams. Removable covers characterized by a blanket-stitching. Available blanket-stitching colours: White 1000, Spritz 4525, Avio 6125, Perla 6375, Ardesia 6450, Grafite 6525, Bordeaux 8125.

Sofa, Polsterung aus Polyurethanschaum, abnehmbare Hussen mit Langettenstich verziert. Farben für den Langettenstich: White 1000, Spritz 4525, Avio 6125, Perla 6375, Ardesia 6450, Grafite 6525, Bordeaux 8125.

Canapé déhoussable, rembourrage en mousse polyuréthane, housses avec bordure au point de feston. Couleurs de la bordure au point de feston: White 1000, Spritz 4525, Avio 6125, Perla 6375, Ardesia 6450, Grafite 6525, Bordeaux 8125.

MIK 12

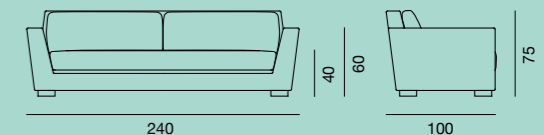

p. 4-5 / 62-63

Divano, imbottitura in poliuretano espanso, rivestimenti sfoderabili rifiniti con cucitura punto cavallo. Finiture punto cavallo disponibili: White 1000, Spritz 4525, Avio 6125, Perla 6375, Ardesia 6450, Grafite 6525, Bordeaux 8125.

Sofa, upholstered with polyurethane foams. Removable covers characterized by a blanket-stitch. Available blanket-stitching colours: White 1000, Spritz 4525, Avio 6125, Perla 6375, Ardesia 6450, Grafite 6525, Bordeaux 8125.

Sofa, Polsterung aus Polyurethanschaum, abnehmbare Hussen mit Langettenstich verziert. Farben für den Langettenstich: White 1000, Spritz 4525, Avio 6125, Perla 6375, Ardesia 6450, Grafite 6525, Bordeaux 8125.

Canapé déhoussable, rembourrage en mousse polyuréthane, housses avec bordure au point de feston. Couleurs de la bordure au point de feston: White 1000, Spritz 4525, Avio 6125, Perla 6375, Ardesia 6450, Grafite 6525, Bordeaux 8125.

MOON 33

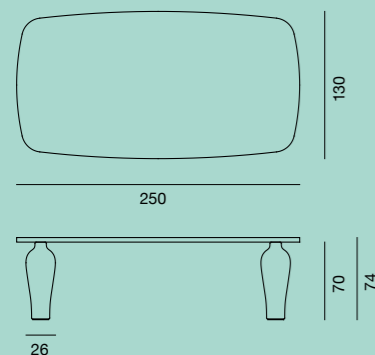

p. 96-97 / 99

Tavolo, piano in fusione di alluminio o in marmo bianco di Carrara. Gambe in ceramica blu.
 Table, available with cast aluminium or white Carrara marble top. Legs in blue ceramic.
 Tisch mit Platte aus Gussaluminium oder aus weißem Carrara-Marmor. Füße aus blauer Keramik.
 Table, dessus en fonte d'aluminium ou en marbre blanc de Carrare. Pieds en céramique bleu.

MOON 34

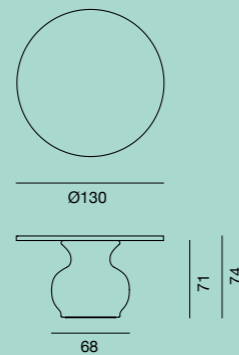

Tavolo, piano in fusione di alluminio o in marmo bianco di Carrara. Base in ceramica blu.
 Table, available with cast aluminium or white Carrara marble top. Base in blue ceramic.
 Tisch mit Platte aus Gussaluminium oder aus weißem Carrara-Marmor. Unterbau aus blauer Keramik.
 Table, dessus en fonte d'aluminium ou en marbre blanc de Carrare. Piétement en céramique bleu.

MOON 36

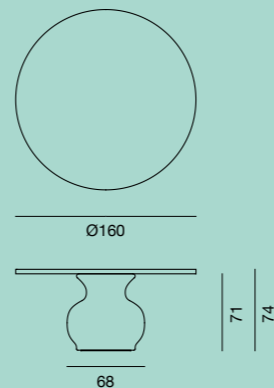

p. 111 / 113

Tavolo, piano in fusione di alluminio o in marmo bianco di Carrara. Base in ceramica blu.
 Table, available with cast aluminium or white Carrara marble top. Base in blue ceramic.
 Tisch mit Platte aus Gussaluminium oder aus weißem Carrara-Marmor. Unterbau aus blauer Keramik.
 Table, dessus en fonte d'aluminium ou en marbre blanc de Carrare. Piétement en céramique bleu.

MORE 04 L-R

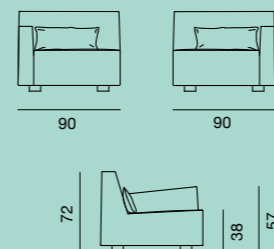

Elemento componibile terminale, imbottitura in poliuretano espanso, rivestimenti sfoderabili, bracciolo sinistro (L) o destro (R). Un cuscino poggiatesta in misto piuma da 60x30 cm.
 Modular end element, upholstered with polyurethane foams, removable covers, left (L) or right (R) armrest. Lumbar cushion in dacron and down 60x30 cm.
 Anbau-Endelement, Polsterung aus Polyurethanschaum, abziehbar, Armlehne links (L) oder rechts (R). Ein Nierenkissen aus Dacron und Daunenfüllung 60x30 cm.
 Élément terminaison pour composition, rembourrage en mousse polyuréthane, déhoussable, accoudoir à gauche (L) ou bien à droite (R). Un coussin cale-reins en dacron et plume 60x30 cm.

MORE 05

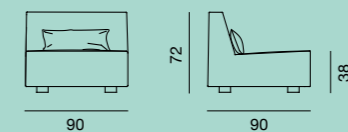

Poltrona componibile senza braccioli, imbottitura in poliuretano espanso, rivestimenti sfoderabili. Un cuscino poggiatesta in misto piuma da 60x30 cm.
 Modular lounge chair w/o arms, upholstered with polyurethane foams, removable covers. One lumbar cushion in dacron and down 60x30 cm.
 Anbauelement ohne Armlehnen, Polsterung aus Polyurethanschaum, abziehbar. Ein Nierenkissen aus Dacron und Daunenfüllung 60x30 cm.
 Élément – chauffeuse, pour composition, rembourrage en mousse polyuréthane, déhoussable. Un coussin cale-reins en dacron et plume 60x30 cm.

MORE 06

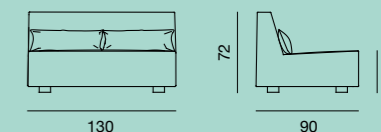

p. 9 / 11 / 70-71 / 72-73 / 88-89

Divanetto due posti componibile senza braccioli, imbottitura in poliuretano espanso, rivestimenti sfoderabili. Due cuscini poggiatesta in misto piuma da 60x30 cm.
 Modular love seat w/o arms, upholstered with polyurethane foams, removable covers. Two lumbar cushions in dacron and down 60x30 cm.
 2-sitziges Anbausofa ohne Armlehnen, Polsterung aus Polyurethanschaum, abziehbar. Zwei Nierenkissen aus Dacron und Daunenfüllung 60x30 cm.
 Canapé deux places, pour composition, rembourrage en mousse polyuréthane, déhoussable. Deux coussins cale reins en dacron et plume 60x30 cm.

MOON 39

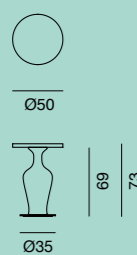

p. 91 / 102 / 104

Tavolino, piano in fusione di alluminio, in marmo o in legno. Finiture legno disponibili: noce Canaletto naturale; rovere sbiancato o laccato bianco, grigio, avio, nero. Colonna in ceramica blu, basamento in fusione di ghisa.
 Tee table, available with cast aluminium, marble or wooden top. Available wood finishes: natural lacquered American walnut; bleached oak; white, grey, air force blue, black lacquered oak. Column in blue ceramic, base in cast iron.
 Tee-Tisch mit Platte aus Gussaluminium, Marmor oder Holz. Lieferbare Farbausführungen: Nussbaum natur lasiert; Eiche gebleicht; Eiche weiß, grau, schieferblau, schwarz lackiert. Säule aus blauer Keramik, Sockel aus Gusseisen.
 Table de thé, dessus en fonte d'aluminium, en marbre ou en bois. Finitions du bois disponibles: noyer américain verni naturel; chêne blanchi; chêne laqué blanc, gris, bleu ardoise, noir. Colonne en céramique bleue, base en fonte.

MOON 40

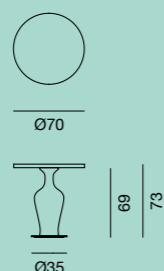

Tavolino, piano in fusione di alluminio, in marmo o in legno. Finiture legno disponibili: noce Canaletto naturale; rovere sbiancato o laccato bianco, grigio, avio, nero. Colonna in ceramica blu, basamento in fusione di ghisa.
 Tee table, available with cast aluminium, marble or wooden top. Available wood finishes: natural lacquered American walnut; bleached oak; white, grey, air force blue, black lacquered oak. Column in blue ceramic, base in cast iron.
 Tee-Tisch mit Platte aus Gussaluminium, Marmor oder Holz. Lieferbare Farbausführungen: Nussbaum natur lasiert; Eiche gebleicht; Eiche weiß, grau, schieferblau, schwarz lackiert. Säule aus blauer Keramik, Sockel aus Gusseisen.
 Table de thé, dessus en fonte d'aluminium, en marbre ou en bois. Finitions du bois disponibles: noyer américain verni naturel; chêne blanchi; chêne laqué blanc, gris, bleu ardoise, noir. Colonne en céramique bleue, base en fonte.

MOON 42

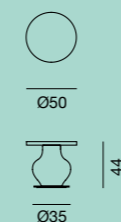

p. 87 / 89

Tavolino, piano in fusione di alluminio, in marmo o in legno. Finiture legno disponibili: noce Canaletto naturale; rovere sbiancato o laccato bianco, grigio, avio, nero. Colonna in ceramica blu, basamento in fusione di ghisa.
 Side table, available with cast aluminium, marble or wooden top. Available wood finishes: natural lacquered American walnut; bleached oak; white, grey, air force blue, black lacquered oak. Column in blue ceramic, base in cast iron.
 Beistelltisch mit Platte aus Gussaluminium, Marmor oder Holz. Lieferbare Farbausführungen: Nussbaum natur lasiert; Eiche gebleicht; Eiche weiß, grau, schieferblau, schwarz lackiert. Säule aus blauer Keramik, Sockel aus Gusseisen.
 Guéridon, dessus en fonte d'aluminium, en marbre ou en bois. Finitions du bois disponibles: noyer américain verni naturel; chêne blanchi; chêne laqué blanc, gris, bleu ardoise, noir. Colonne en céramique bleue, base en fonte.

MORE 06 AN

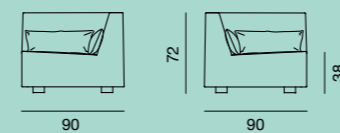

Elemento componibile ad angolo, imbottitura in poliuretano espanso, rivestimenti sfoderabili. Due cuscini poggiatesta in misto piuma da 60x30 cm.
 Modular corner element, upholstered with polyurethane foams, removable covers. Two lumbar cushions in dacron and down 60x30 cm.
 Anbau-Eckelement, Polsterung aus Polyurethanschaum, abziehbar. Zwei Nierenkissen aus Dacron und Daunenfüllung 60x30 cm.
 Élément d'angle pour composition, rembourrage en mousse polyuréthane, déhoussable. Deux coussins cale-reins en dacron et plume 60x30 cm.

MORE 07 L-R

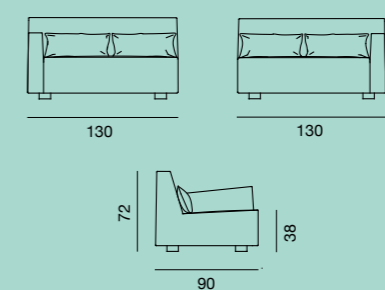

p. 8 / 11 / 19 / 21 / 88 / 110

Elemento componibile terminale, imbottitura in poliuretano espanso, rivestimenti sfoderabili, bracciolo sinistro (L) o destro (R). Due cuscini poggiatesta in misto piuma da 60x30 cm.
 Modular end element, upholstered with polyurethane foams, removable covers, left (L) or right (R) armrest. Two lumbar cushions in dacron and down 60x30 cm.
 Anbau-Endelement, Polsterung aus Polyurethanschaum, abziehbar, Armlehne links (L) oder rechts (R). Zwei Nierenkissen aus Dacron und Daunenfüllung 60x30 cm.
 Élément terminaison pour composition, rembourrage en mousse polyuréthane, déhoussable, accoudoir à gauche (L) ou bien à droite (R). Deux coussins cale-reins en dacron et plume 60x30 cm.

MORE 08 P

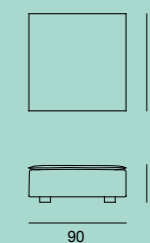

p. 10 / 11 / 61 / 73

Pouf componibile, imbottitura in poliuretano espanso, rivestimento sfoderabile.
 Modular ottoman, upholstered with polyurethane foams, removable cover.
 Anbauhocker, Polsterung aus Polyurethanschaum, abziehbar.
 Pouf, pour composition, rembourrage en mousse polyuréthane, déhoussable.

MORE 10

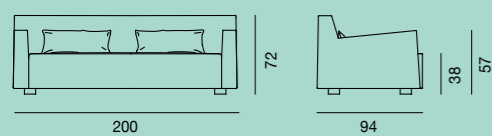

p. 90-91

Divano, imbottitura in poliuretano espanso. Rivestimenti sfoderabili. Due cuscini poggiatesta in misto piuma da 60x30 cm.

Sofa, upholstery with polyurethane foams, removable covers. Two lumbar cushions in dacron and down 60x30 cm.

Sofa, Polsterung aus Polyurethanschaum, abziehbar. Zwei Nierenkissen aus Dacron und Daunenfüllung 60x30 cm.

Canapé, rembourrage en mousse polyuréthane, déhoussable. Deux cousins cale-reins en dacron et plume 60x30 cm.

MORE 12

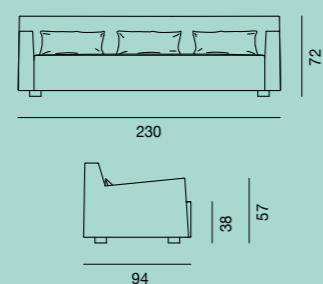

p. 24-25

Divano, imbottitura in poliuretano espanso. Rivestimenti sfoderabili. Tre cuscini poggiatesta in misto piuma da 60x30 cm.

Sofa, upholstery with polyurethane foams, removable covers. Three lumbar cushions in dacron and down 60x30 cm.

Sofa, Polsterung aus Polyurethanschaum, abziehbar. Drei Nierenkissen aus Dacron und Daunenfüllung 60x30 cm.

Canapé, rembourrage en mousse polyuréthane, déhoussable. Trois cousins cale-reins en dacron et plume 60x30 cm.

MORE 20 L-R

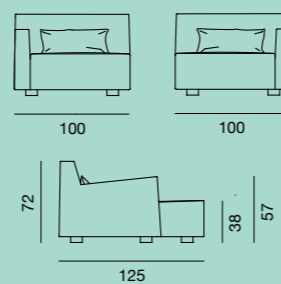

p. 70 / 72

Dormeuse componibile, imbottitura in poliuretano espanso, rivestimenti sfoderabili, bracciolo sinistro (L) o destro (R). Un cuscino poggiatesta in misto piuma da 60x30 cm.

Modular dormeuse, upholstered with polyurethane foams, removable covers, left (L) or right (R) armrest. One lumbar cushion in dacron and down 60x30 cm.

Anbau-Diwan, Polsterung aus Polyurethanschaum, abziehbar, Armlehne links (L) oder rechts (R). Ein Nierenkissen aus Dacron und Daunenfüllung 60x30 cm.

Méridienne pour composition, rembourrage en mousse polyuréthane, déhoussable, accoudoir à gauche (L) ou bien à droite (R). Un coussin cale-reins en dacron et plume 60x30 cm.

MORE 25 / 25P

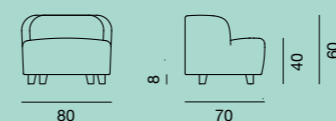

p. 58 / 103 / 106-107

Poltrona, imbottitura in poliuretano espanso. Rivestimento sfoderabile e fondo libero con cucitura taglia e cucù (MORE 25) oppure con piping (MORE 25 P). Piedi in fusione di alluminio lucidato, in noce Canaletto verniciato naturale o faggio laccato bianco, grigio, avio o nero.

Armchair, upholstered with polyurethane foams, removable cover, free fastening, with stitching (MORE 25) or with piping (MORE 25 P). Feet in cast polished aluminium, in natural lacquered American walnut or white, grey, air force blue, black lacquered beechwood.

Sessel, Polsterung aus Polyurethanschaum, abziehbare Husse in loser Ausführung mit Overlock-Nähten (MORE 25) oder mit Keder (MORE 25 P). Füße aus Gussaluminium poliert, aus Nussbaum natur lasiert oder aus Buche, weiß, grau, schieferblau oder schwarz lackiert.

Fauteuil, rembourrage en mousse polyuréthane, housse amovible en finition flottante avec surpiquères (MORE 25) ou bien avec passe poil (MORE 25 P). Pieds en fonte d'aluminium poli, en noyer américain verni naturel ou en hêtre laqué blanc, gris, bleu ardoise ou noir.

NEWS 108



p. 87 / 88-89 / 94-95

Tavolino / pouf in fogli di carta di giornale pressati e verniciati blu. Top in MDF laccato nero lucido.

Side table / ottoman made of newspaper paper, pressed and blue lacquered. Top in MDF, glossy black lacquered.

Beistelltisch / Hocker aus Zeitungspapier, gepresst und blau lackiert. Platte aus MDF, glänzend schwarz lackiert.

Guéridon / pouf en papier journal pressé et laqué bleu. Plateau en MDF, laqué noir brillant.

NEXT 18

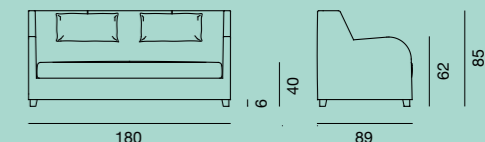

p. 83 / 84-85

Divano, imbottitura in poliuretano espanso. Rivestimento sfoderabile con cucitura taglia e cucù e fondo libero. Su richiesta con fondo velcrato. Piedi in fusione di alluminio lucidato, in noce Canaletto verniciato naturale o faggio laccato bianco, grigio, avio o nero. Due cuscini poggiatesta da 55x25 cm in misto piuma.

Sofa, upholstered with polyurethane foams, removable cover with stitching and free fastening. Upon request with velcro fastening. Feet in cast polished aluminium, in natural lacquered American walnut or white, grey, air force blue, black lacquered beechwood. Two headrest cushions in Dacron and down 55x25 cm.

Sofa, Polsterung aus Polyurethanschaum, abnehmbare Husse mit Overlock-Nähten (lose Ausführung). Auf Wunsch auch in straffer Ausführung. Füße aus Gussaluminium poliert, aus Nussbaum natur lasiert oder aus Buche, weiß, grau, schieferblau oder schwarz lackiert. Zwei Nackenkissen aus Dacron und Daunenfüllung 55x25 cm.

Canapé, rembourrage en mousse polyuréthane, housse amovible flottante avec surpiquères. Disponible aussi en finition tendue. Pieds en fonte d'aluminium poli, en noyer américain verni naturel ou en hêtre laqué blanc, gris, bleu ardoise ou noir. Deux coussins repose tête en dacron et plume 55x25 cm.

MORE 21 AN

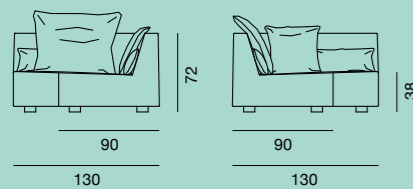

p. 8 / 11

Elemento componibile ad angolo, imbottitura in poliuretano espanso, rivestimenti sfoderabili. Un cuscino di schienale in misto piuma da 80x80 cm, uno da 60x60 cm e due cuscini poggiatesta da 60x30 cm.

Modular corner element, upholstered with polyurethane foams, removable covers. One back cushions in dacron and down 80x80 cm, one 60x60 cm and two lumbar cushions 60x30 cm.

Anbau-Eckelement, Polsterung aus Polyurethanschaum, abziehbar. Ein Rückenkissen aus Dacron und Daunenfüllung 80x80 cm, ein 60x60 cm und zwei Nierenkissen 60x30 cm.

Elément d'angle pour composition, rembourrage en mousse polyuréthane, déhoussable. Un coussin dossier en dacron et plume 80x80 cm, un 60x60 cm et deux coussins cale-reins 60x30 cm.

MORE 22 L-R

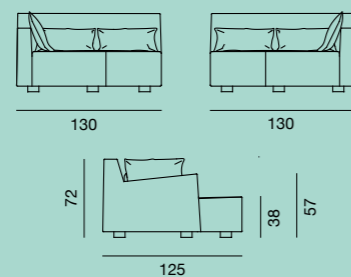

p. 8-9 / 11 / 19 / 21 / 71 / 73 / 89

Dormeuse componibile, imbottitura in poliuretano espanso, rivestimenti sfoderabili, bracciolo sinistro (L) o destro (R). Un cuscino di schienale in misto piuma da 60x60 cm e due cuscini poggiatesta da 60x30 cm.

Modular dormeuse, upholstered with polyurethane foams, removable covers, left (L) or right (R) armrest. One back cushions in dacron and down 60x60 cm and two lumbar cushions 60x30 cm.

Anbau-Diwan, Polsterung aus Polyurethanschaum, abziehbar, Armlehne links (L) oder rechts (R). Ein Rückenkissen aus Dacron und Daunenfüllung 60x60 cm und zwei Nierenkissen 60x30 cm.

Méridienne pour composition, rembourrage en mousse polyuréthane, déhoussable, accoudoir à gauche (L) ou bien à droite (R). Un coussin dossier en dacron et plume 60x60 cm et deux coussins cale-reins 60x30 cm.

MORE 24 / 24P

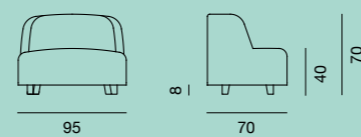

p. 47 / 48-49 / 94-95

Poltrona, imbottitura in poliuretano espanso. Rivestimento sfoderabile e fondo libero con cucitura taglia e cucù (MORE 24) oppure con piping (MORE 24 P). Piedi in fusione di alluminio lucidato, in noce Canaletto verniciato naturale o faggio laccato bianco, grigio, avio o nero.

Armchair, upholstered with polyurethane foams, removable cover, free fastening, with stitching (MORE 24) or with piping (MORE 24 P). Feet in cast polished aluminium, in natural lacquered American walnut or white, grey, air force blue, black lacquered beechwood.

Sessel, Polsterung aus Polyurethanschaum, abziehbare Husse in loser Ausführung mit Overlock-Nähten (MORE 24) oder mit Keder (MORE 24 P). Füße aus Gussaluminium poliert, aus Nussbaum natur lasiert oder aus Buche, weiß, grau, schieferblau oder schwarz lackiert.

Fauteuil, rembourrage en mousse polyuréthane, housse amovible en finition flottante avec surpiquères (MORE 24) ou bien avec passe poil (MORE 24 P). Pieds en fonte d'aluminium poli, en noyer américain verni naturel ou en hêtre laqué blanc, gris, bleu ardoise ou noir.

NEXT 18P

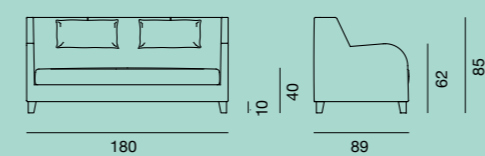

Divano, imbottitura in poliuretano espanso. Rivestimento sfoderabile con piping e fondo velcrato. Su richiesta con fondo libero. Piedi in fusione di alluminio lucidato, in noce Canaletto verniciato naturale o faggio laccato bianco, grigio, avio o nero. Due cuscini poggiatesta da 55x25 cm in misto piuma.

Sofa, upholstered with polyurethane foams, removable cover with piping and Velcro fastening. Upon request with free fastening. Feet in cast polished aluminium, in natural lacquered American walnut or white, grey, air force blue, black lacquered beechwood. Two headrest cushions in Dacron and down 55x25 cm.

Sofa, Polsterung aus Polyurethanschaum, abnehmbare Husse mit Keder (straffe Ausführung). Auf Wunsch auch in loser Ausführung. Füße aus Gussaluminium poliert, aus Nussbaum natur lasiert oder aus Buche, weiß, grau, schieferblau oder schwarz lackiert. Zwei Nackenkissen aus Dacron und Daunenfüllung 55x25 cm.

Canapé, rembourrage en mousse polyuréthane, housse amovible tendue avec passe poil. Disponible aussi en finition flottante. Pieds en fonte d'aluminium poli, en noyer américain verni naturel ou en hêtre laqué blanc, gris, bleu ardoise ou noir. Deux coussins repose tête en dacron et plume 55x25 cm.

NEXT 22

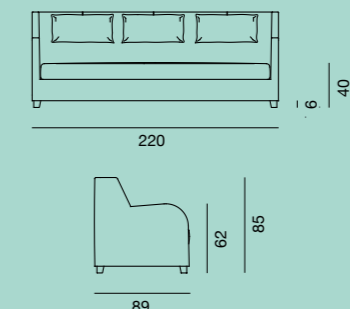

Divano, imbottitura in poliuretano espanso. Rivestimento sfoderabile con cucitura taglia e cucù e fondo libero. Su richiesta con fondo velcrato. Piedi in fusione di alluminio lucidato, in noce Canaletto verniciato naturale o faggio laccato bianco, grigio, avio o nero. Tre cuscini poggiatesta da 55x25 cm in misto piuma.

Sofa, upholstered with polyurethane foams, removable cover with stitching and free fastening. Upon request with Velcro fastening. Feet in cast polished aluminium, in natural lacquered American walnut or white, grey, air force blue, black lacquered beechwood. Three headrest cushions in Dacron and down 55x25 cm.

Sofa, Polsterung aus Polyurethanschaum, abnehmbare Husse mit Overlock-Nähten (lose Ausführung). Auf Wunsch auch in straffer Ausführung. Füße aus Gussaluminium poliert, aus Nussbaum natur lasiert oder aus Buche, weiß, grau, schieferblau oder schwarz lackiert. Drei Nackenkissen aus Dacron und Daunenfüllung 55x25 cm.

Canapé, rembourrage en mousse polyuréthane, housse amovible flottante avec surpiquères. Disponible aussi en finition tendue. Pieds en fonte d'aluminium poli, en noyer américain verni naturel ou en hêtre laqué blanc, gris, bleu ardoise ou noir. Trois coussins repose tête dossier en dacron et plume 55x25 cm.

NEXT 22P

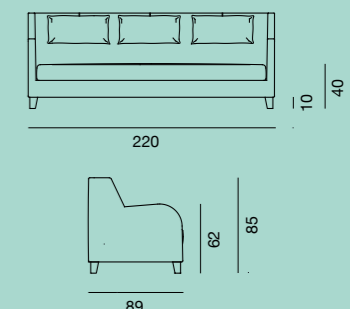

p. 102

Divano, imbottitura in poliuretano espanso. Rivestimento sfoderabile con piping e fondo velcrato. Su richiesta con fondo libero. Piedi in fusione di alluminio lucidato, in noce Canaletto verniciato naturale o faggio laccato bianco, grigio, avio o nero. Tre cuscini poggiatesta da 55x25 cm in misto piuma.

Sofa, upholstered with polyurethane foams, removable cover with piping and Velcro fastening. Upon request with free fastening. Feet in cast polished aluminium, in natural lacquered American walnut or white, grey, air force blue, black lacquered beechwood. Three headrest cushions in Dacron and down 55x25 cm.

Sofa, Polsterung aus Polyurethanschaum, abnehmbare Husse mit Keder (straffe Ausführung). Auf Wunsch auch in loser Ausführung. Füße aus Gussaluminium poliert, aus Nussbaum natur lasiert oder aus Buche, weiß, grau, schieferblau oder schwarz lackiert. Drei Nackenkissen aus Dacron und Daunenfüllung 55x25 cm.

Canapé, rembourrage en mousse polyuréthane, housse amovible tendue avec passe poil. Disponible aussi en finition flottante. Pieds en fonte d'aluminium poli, en noyer américain verni naturel ou en hêtre laqué blanc, gris, bleu ardoise ou noir. Trois coussins repose tête en dacron et plume 55x25 cm.

NEXT 232 / 236

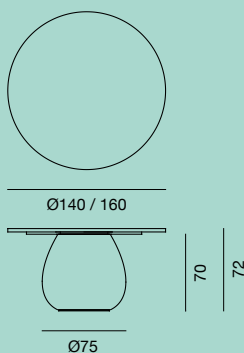

p. 66-67 / 68

Tavolo tondo, base centrale in cemento finitura crackle. Piano in abete spazzolato a mano laccato grigio o bianco lucido o in marmo bianco Carrara (20 mm).

Round table, central concrete base, crackle finishing. Top in handbrushed glossy gray or white lacquered pine or in white Carrara marble (20 mm).

Runder Tisch, Unterbau aus Beton in Craquelé-Optik. Platte aus handgebürsteter Pinie, glänzend grau oder weiss lackiert oder aus weißem Carrara-Marmor (20 mm).

Table ronde, piétement en béton, effet craquelé, plateau en sapin brossé à la main, laqué gris ou blanc brillant ou en marbre blanc de Carrare (20 mm).

NEXT 998 / 999

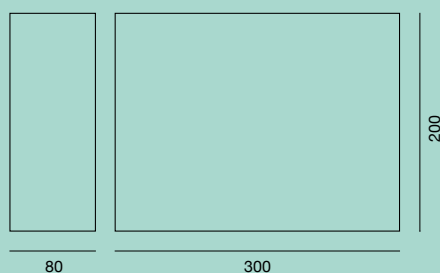

p. 16-17 / 20-21 / 60-61 / 70-71 / 84-85 / 90-91

Tappeto tessuto manualmente, 80x200 cm (Next 998) o 200x300 cm (Next 999). Composizione: 55% viscosa, 30% cotone, 15% lana. Disponibile in 4 colori: Silver, Blu, Slate, Brown.

Hand loom knotted rug, 80x200 cm (Next 998) or 200x300 cm (Next 999). Content - 55% viscose, 30% cotton, 15% wool. Available in 4 colours: Silver, Blu, Slate, Brown.

Handgewebter Teppich, 80x200 cm (Next 998) oder 200x300 cm (Next 999). Zusammensetzung: 55% Viskose, 30% Baumwolle, 15% Wolle. Lieferbar in vier Farben: Silver, Blu, Slate, Brown.

Tapis tissé main, 80x200 cm (Next 998) ou 200x300 cm (Next 999). Composition: 55% viscose, 30% coton, 15% laine. Disponible en quatre couleurs: Silver, Blu, Slate, Brown.

NUVOLA 05

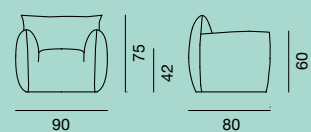

p. 60 / 86

Poltrona con imbottitura in poliuretano espanso rivestita con trapuntino imbottito con piuma d'oca e fiocco di fibra di poliestere. Rivestimento sfoderabile.

Lounge chair, upholstered with polyurethane foam covered by a goose down and polyester fibre quilting, removable cover.

Sessel, Polsterung aus Polyurethanschaum, Weißpolsterbezug gefüllt mit Daunen und Polyesterflöckchen, abziehbar.

Fauteuil déhoussable, rembourrage en mousse polyuréthane avec couche ultérieure en duvet et polyester.

UP 23

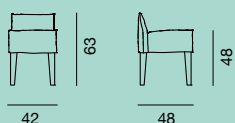

p. 30 / 68 / 101

Sedia, imbottitura in poliuretano espanso. Rivestimento sfoderabile. Piedi in noce Canaletto verniciato naturale o faggio laccato bianco, grigio, avio, nero.

Chair, upholstery with polyurethane foam, removable cover. Feet in natural lacquered American walnut or white, grey, air force blue, black lacquered beech.

Stuhl, Polsterung aus Polyurethanschaum, abziehbar; Füße aus Nussbaum natur lasiert oder aus Buche weiß, grau, schieferblau oder schwarz lackiert.

Chaise, rembourrage en mousse polyuréthane, déhoussable. Pieds en noyer américain vernis naturel ou bien en hêtre laqué blanc, gris, bleu ardoise, noir.

UP 28

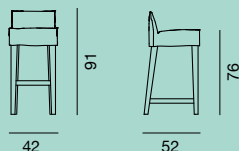

p. 6-7 / 98

Sgabello, imbottitura in poliuretano espanso. Rivestimento sfoderabile. Piedi in noce Canaletto verniciato naturale o faggio laccato bianco, grigio, avio, nero.

Bar stool, upholstery with polyurethane foam, removable cover. Feet in natural lacquered American walnut or white, grey, air force blue, black lacquered beech.

Barhocker, Polsterung aus Polyurethanschaum, abziehbar; Füße aus Nussbaum natur lasiert oder aus Buche weiß, grau, schieferblau oder schwarz lackiert.

Tabouret, rembourrage en mousse polyuréthane, déhoussable. Pieds en noyer américain vernis naturel ou bien en hêtre laqué blanc, gris, bleu ardoise, noir.

UP 80 S / F / E / G / Q / EK

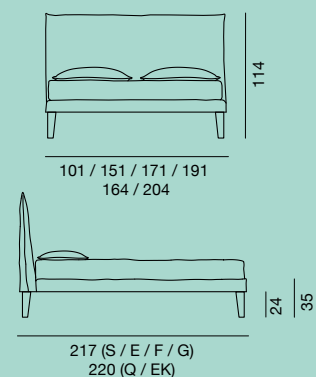

p. 16-17 / 39

Letto imbottito sfoderabile con giroletto smontabile. Imbottitura in poliuretano espanso. Piedi in noce Canaletto verniciato naturale o faggio laccato bianco, grigio, avio, nero. Solo letto, per rete 90x200 cm (S), 140X200 cm (F), 160X200 cm (E), 180X200 cm (G), 153X203 cm (Q), 193x203 cm (EK).

Upholstered knock-down bed, removable cover. Feet in natural lacquered American walnut or white, grey, air force blue, black lacquered beech. Only bed, for slat 90x200 cm (S), 140X200 cm (F), 160X200 cm (E), 180X200 cm (G), 153X203 cm (Q), 193x203 cm (EK)

Polsterbett zerlegbar und abziehbar; Füße aus Nussbaum natur lasiert oder aus Buche weiß, grau, schieferblau oder schwarz lackiert. Nur Bett, für Lattenrost 90x200 cm (S), 140X200 cm (F), 160X200 cm (E), 180X200 cm (G), 153X203 cm (Q), 193x203 cm (EK).

Lit rembourré, démontable et déhoussable. Pieds en noyer américain vernis naturel ou bien en hêtre laqué blanc, gris, bleu ardoise, noir. Lit seul, pour sommier 90x200 cm (S), 140X200 cm (F), 160X200 cm (E), 180X200 cm (G), 153X203 cm (Q), 193x203 cm (EK)

CREDITS:

creative direction **PAOLA NAVONE**
 product design **OTTO / DOMENICO DIEGO,**
MARCO OLGIATI, TATIANA KHNYZHOVA
 style coordinator **OTTO / CRISTINA PETTENUZZO**
 photo **SYLVIE BECQUET**
 photo assistant **PASCALE THIEBOT, ERICA FADINI, BIANCA PULEO**
 concept & styling **BEATRICE ROSSETTI**
VERONICA LEALI, WILSON POLEGATO, GIOIA SOPELSA
 graphic **GENNY CANTON STUDIO**
 separations **LUCE SRL**
 print **SINCROMIA** Cod. 181300

THANKS TO:

ALESSI ALESSI.IT P. 11 / 12 / 13 / 16 / 30 / 31 / 87
 ALESSIO SARRI ALESSIOSARRI.COM P. 71 / 73 / 88 / 96 / 97 / 99 / 101
 ANNA VINZI ANNAVINZI.COM P. 49 / 73 / 75 / 77 / 102 / 103
 ARNOLDO DI CAMBIO ARNOLFODICAMBIO.COM P. 2 / 6 / 7 / 8 / 86 / 87 / 89 / 96 /
 97 / 99
 ASTEP STEP.DESIGN P. 37 / 106
 BOSA CERAMICHE BOSATRADE.COM P. 12 / 13 / 46 / 49 / 92
 BROGGI BROGGI.IT P. 32 / 86 / 87 / 96 / 97 / 99 / 113
 CC TAPIS CC-TAPIS.COM P. 8 / 9 / 10 / 11 / 28 / 29 / 40 / 42 / 43 / 44 / 45 / 92 / 93 /
 102 / 103 / 106 / 107
 CECCHI E CECCHI CECCHIECECCHI.IT P. 40 / 56 / 57 / 91
 CORAXART COSMI.CORAXART.COM P. 73 / 75 / 76 / 77 / 95
 CUOIUUM CUOIUUM.COM P. 39 / 42 / 43 / 45 / 46 / 48 / 93
 DIAMANTINI E DOMENICONI DIAMANTINIDOMENICONI.IT P. 52 / 66 / 79
 FONTANAARTE FONTANAARTE.COM P. 88 / 92 / 93
 FRANCESCA VERARDO FRANCESCAVERARDO.COM P. 19 / 25 / 27 / 35 / 70 /
 72 / 102
 GALLERIA L'AFFICHE AFFICHE.IT P. 18 / 38 / 85 / 94
 ICHENDORF MILANO ICHENDORFMILANO.COM P. 35 / 50 / 52 / 81 / 103 / 113
 SABINA BELFIORE LUCOVICH COURTESY MARI&CO
 WWW.SABINABELFIORELUCOVICH.COM P. 110
 JAB JAB.DE P. 43
 KASTHALL KASTHALL.COM P. 4 / 5 / 22 / 23 / 24 / 25 / 26 / 62 / 63 / 64 / 78 / 79 / 81
 / 88 / 89 / 94 / 95
 LANGSAM STUDIO INSTAGRAM.COM / LANGSAM.STUDIO P. 51
 MADDALENA SELVINI MADDALENASELVINI.COM P. 19 / 29 / 30 / 32 / 33 / 35 / 113
 MANUFATTO MANUFATTO.INFO P. 90 / 91
 MARTINELLI LUCE MARTINELLILUCE.IT P. 8 / 66 / 71 / 73
 MASON EDITIONS MASON-EDITIONS.COM P. 2 / 7 / 14 / 15 / 92
 MM LAMPADARI MMLAMPADARI.COM P. 6 / 7 / 39
 MOLteni HOME MOLTENIHOME.COM P. 16 / 17 / 40 / 45 / 54
 NAHOOR NAHOOR.COM P. 20 / 54 / 61 / 62 / 65
 NANBAN NAN-BAN.COM P. 61 / 98
 NEO DESIGN ROSANNANEODESIGN.COM P. 22 / 52 / 57
 NORMANN COPENHAGEN NORMANN-COPENHAGEN.COM P. 17 / 25 / 26 / 39 / 43
 / 50 / 52 / 53 / 78 / 81 / 86 / 88 / 89 / 95
 NUDE NUDEGLASS.COM P. 93 / 111 / 113
 OTTICA URBANI OTTICAURBANI.COM P. 29 / 30 / 31 / 46 / 56 / 58 / 81 / 83 / 84 / 90
 PAOLA PARONETTO PAOLA-PARONETTO.COM P. 43 / 48 / 82 / 83 / 84
 RINA MENARDI RINAMENARDI.COM P. 18 / 27 / 43 / 44
 ROBERTA LICINI ROBERTALICINI.COM P. 24 / 25 / 78 / 79 / 81 / 92
 SERAX SERAX.COM P. 14 / 15 / 16 / 17 / 24 / 27 / 35 / 70 / 73 / 96 / 97 / 99
 SIMONA CARDINETTI SIMONACARDINETTI.COM P. 8 / 9 / 10 / 12 / 19 / 24 / 27 / 38
 / 70 / 72
 SOCIETY SOCIETYLIMONTA.COM P. 58 / 59 / 111 / 113
 STONE ITALIANA STONEITALIANA.COM P. 88
 STORIES OF ITALY STORIESOFITALY.COM P. 86 / 93 / 95 / 97 / 97 / 99
 TOOY TOOY.IT P. 28 / 42 / 46 / 48
 URGE DESIGN URGEDESIGN.IT P. 86 / 87
 ZAVA ZAVALUCE.IT P. 86 / 87

GERVASONI™

Gervasoni spa.
 Viale del Lavoro, 88
 33050 Pavia di Udine, Italia
 ph +39 0432 656611
 fax +39 0432 656612
 info@gervasoni1882.com
 www.gervasoni1882.com



ITALIAN DESIGN BRANDS™

Gervasoni fa parte del gruppo
 Italian Design Brands
 Gervasoni is part of Italian
 Design Brands Group

Gervasoni spa è dotata di un Sistema di
 Certificazione di Qualità UNI EN ISO 9001:2008,
 di Gestione Ambientale UNI EN ISO 14001:2004
 e di un Sistema di Certificazione per la gestione
 della Sicurezza e della Salute dei lavoratori
 OHSAS 18001:2012.

Gervasoni spa is certified to UNI EN ISO
 9001:2008 Company Quality System Certifica-
 tion, ISO 14001:2004 Environmental Certifica-
 tion and OHSAS 18001:2012 Certification for
 Health and Safety Management Systems.

**CATMORE18**

GERVASONI™