



barcelona
design



News
2018

Since its origins in the 1970's, BD Barcelona Design has always been an atypical company. Its founders and still current owners, who come from an architectural background rather than the business field, have oriented BD's production from the very start by cultivating beauty, in some cases above function. Accompanied with artisanal processes instead of mass production, the new products always have more proximity to art than industrial design.

Barcelona Design History

45th anniversary book edited by Ramón Úbeda



BD Barcelona Design

News 2018

Stephen Burks²

BD + Bolon⁵

Oscar Tusquets⁶

Measurements⁹



Stephen Burks

Grasso Collection

“Grasso is not fat. Grasso is more than fat. It’s a bit sloppy and overflowing. It’s uncontrollable. These are the ideas of comfort we wanted to play with the Grasso collection. Both, in the upholstered furniture pieces and in the ceramics, there is a feeling of forms reaching the limit of expressiveness. Pushing away from the foundation of the exaggerated expression of traditional overstuffed upholstery allowed us to find an unexpected place of abstraction where the voluminous form not only recalls the traditional smoking lounge chair but also expresses something of the artistically absurd.” Stephen Burks





BD + Bolon



Oscar Tusquets

Red Tulip + Walnut Gaulino table

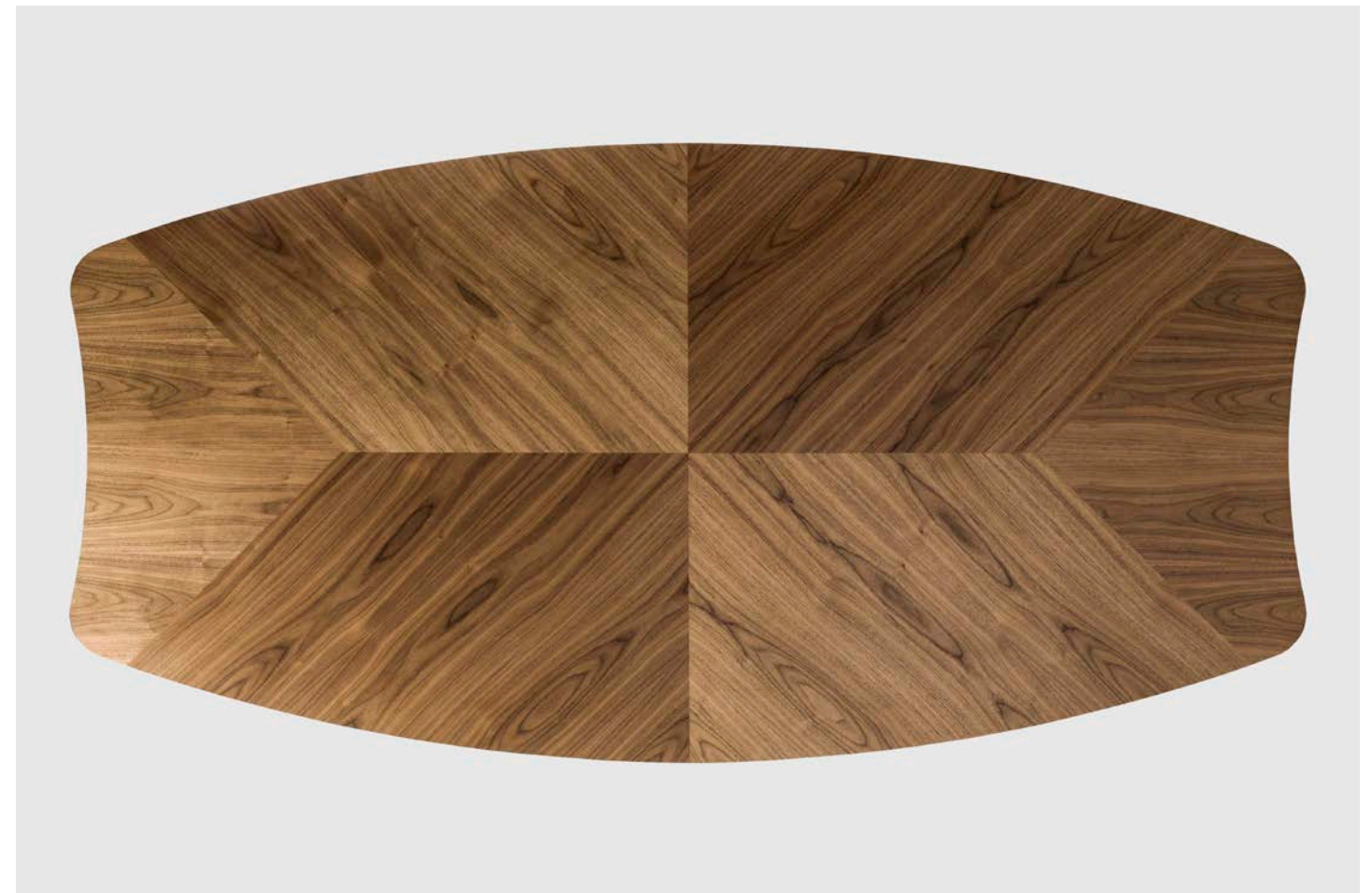

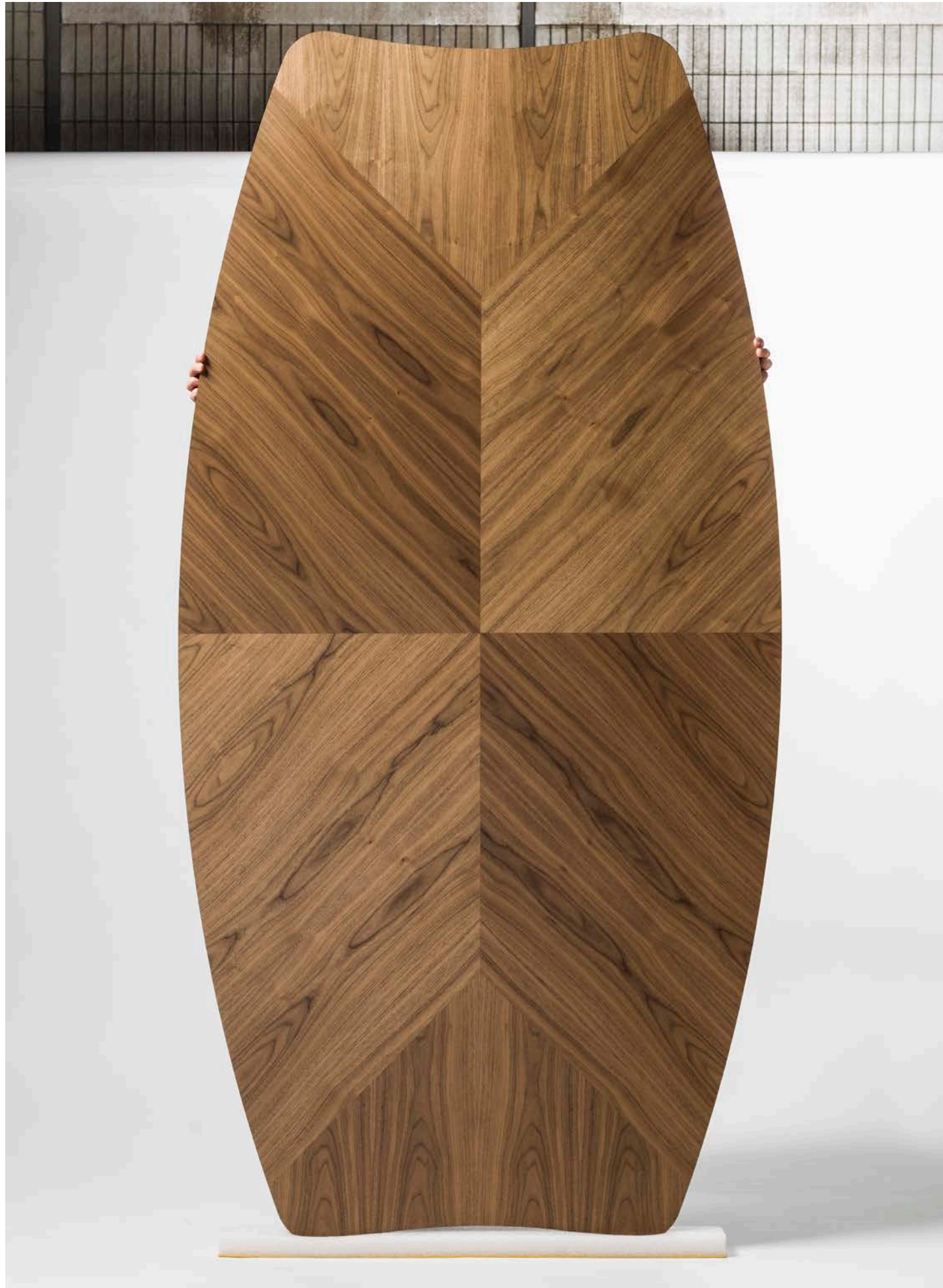

Measurements



News 2018

Art Direction and layout
Ramón Úbeda
Beatriz Hernández

Photos
Eugení Aguiló
Miquel Arnal

Printed by
Nova Era Publications

BD Barcelona Design
 export@bdbarcelona.com
 T. +34 934 586 909

bdbarcelona.com
 bdarteditions.com

Grasso armchair

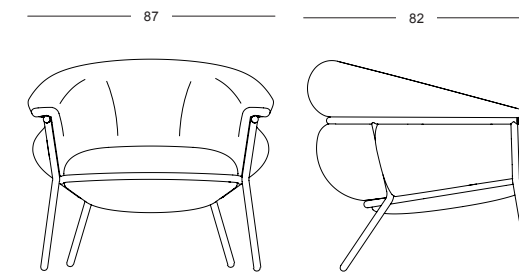

Grasso footrest

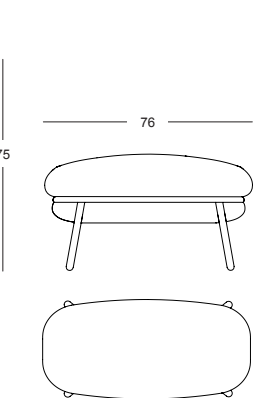

Grasso stool

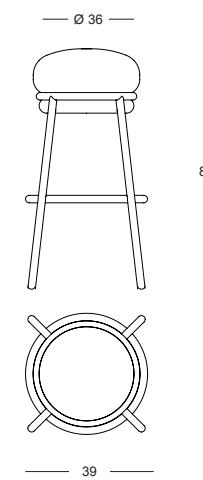

Grasso ceramics

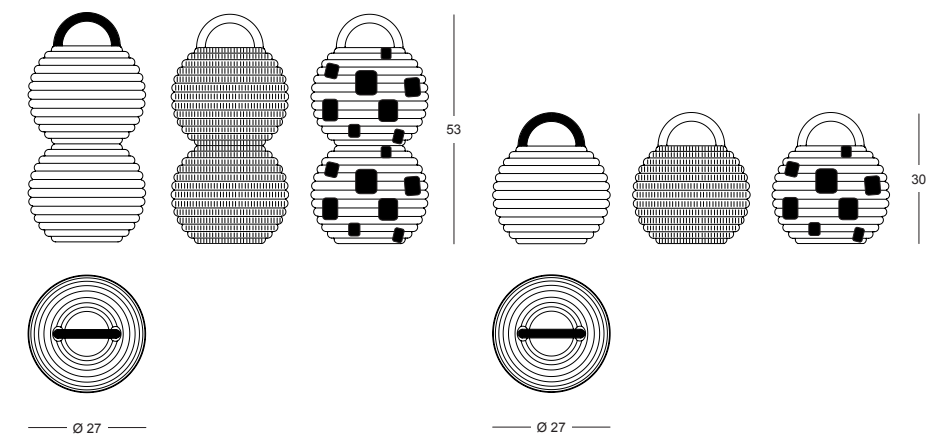

Red Tulip

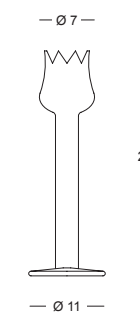

Walnut Gaulino table

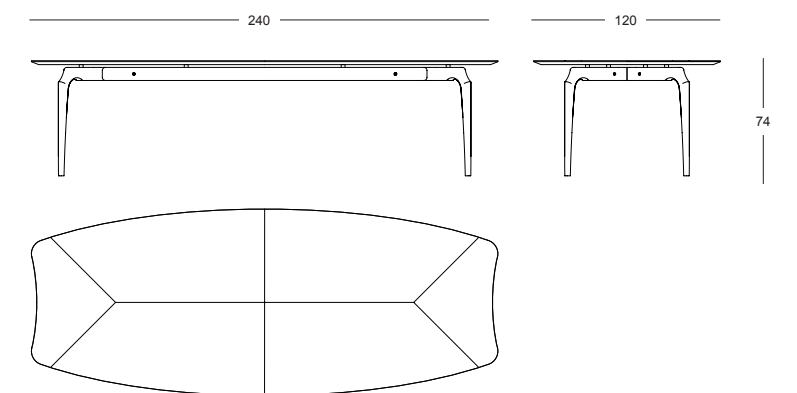

press photo service
bdbarcelona.com/en/press/releases